



US007055073B2

(12) **United States Patent**
Walker et al.

(10) **Patent No.:** **US 7,055,073 B2**
(45) **Date of Patent:** ***May 30, 2006**

(54) **CODING METHOD FOR CODING
PACKETIZED SERIAL DATA WITH LOW
OVERHEAD**

(58) **Field of Classification Search** 714/701;
341/58
See application file for complete search history.

(76) Inventors: **Richard C. Walker**, 3500 Deer Creek Rd., M/S 26U-4, Palo Alto, CA (US) 94304; **Bharadwaj Amrutur**, 3500 Deer Creek Rd., M/S 26U-4, Santa Clara, CA (US) 94304; **Richard W. Dugan**, 370 Trimble Ave., M/S 90UB, San Jose, CA (US) 95131

(56) **References Cited**

U.S. PATENT DOCUMENTS

5,022,051	A *	6/1991	Crandall et al.	375/292
5,438,621	A *	8/1995	Hornak et al.	380/43
5,978,386	A *	11/1999	Hamalainen et al.	370/466
6,208,651	B1 *	3/2001	Van Renesse et al.	370/392
6,317,433	B1 *	11/2001	Galand et al.	370/395.2
6,389,036	B1 *	5/2002	Stewart et al.	370/466
6,718,491	B1 *	4/2004	Walker et al.	714/701

(*) Notice: Subject to any disclaimer, the term of this patent is extended or adjusted under 35 U.S.C. 154(b) by 32 days.

* cited by examiner

This patent is subject to a terminal disclaimer.

Primary Examiner—Stephen M. Baker

(21) Appl. No.: **10/814,442**

(57) **ABSTRACT**

(22) Filed: **Mar. 30, 2004**

Blocks of input data are received. The input data comprises packets of information words. The packets are preceded and followed by control words. A master transition is appended to the beginning of each block to form a respective frame for transmission. The master transition has a sense that depends on whether the block contains any control words. Additionally, for each block that contains one or more control words, a TYPE word indicating a structural property of the block is generated, the block is condensed to accommodate the TYPE word, and the TYPE word is inserted into the block. The coding method provides a very low overhead (3.125%) when implemented as a 64b/66b code.

(65) **Prior Publication Data**

US 2004/0228364 A1 Nov. 18, 2004

Related U.S. Application Data

(63) Continuation of application No. 09/522,782, filed on Mar. 6, 2000, now Pat. No. 6,718,491.

(51) **Int. Cl.**
H03M 13/47 (2006.01)

(52) **U.S. Cl.** 714/701; 341/58

22 Claims, 14 Drawing Sheets

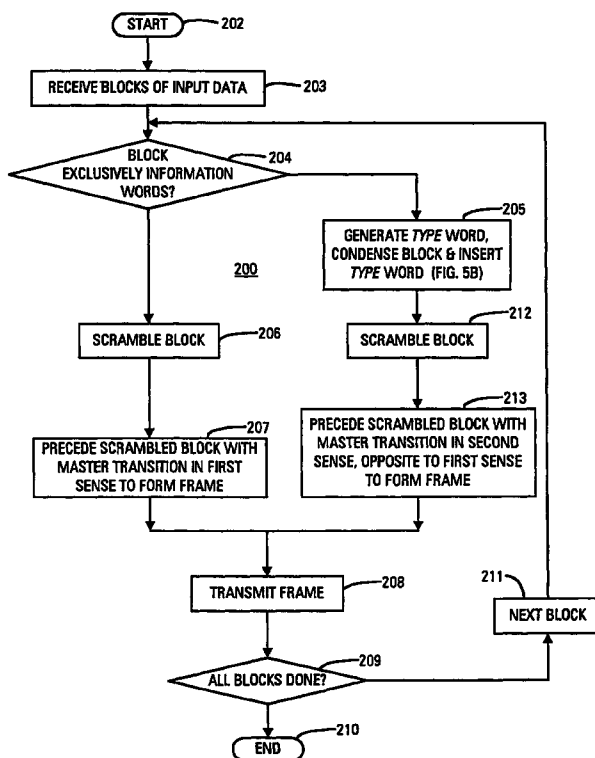

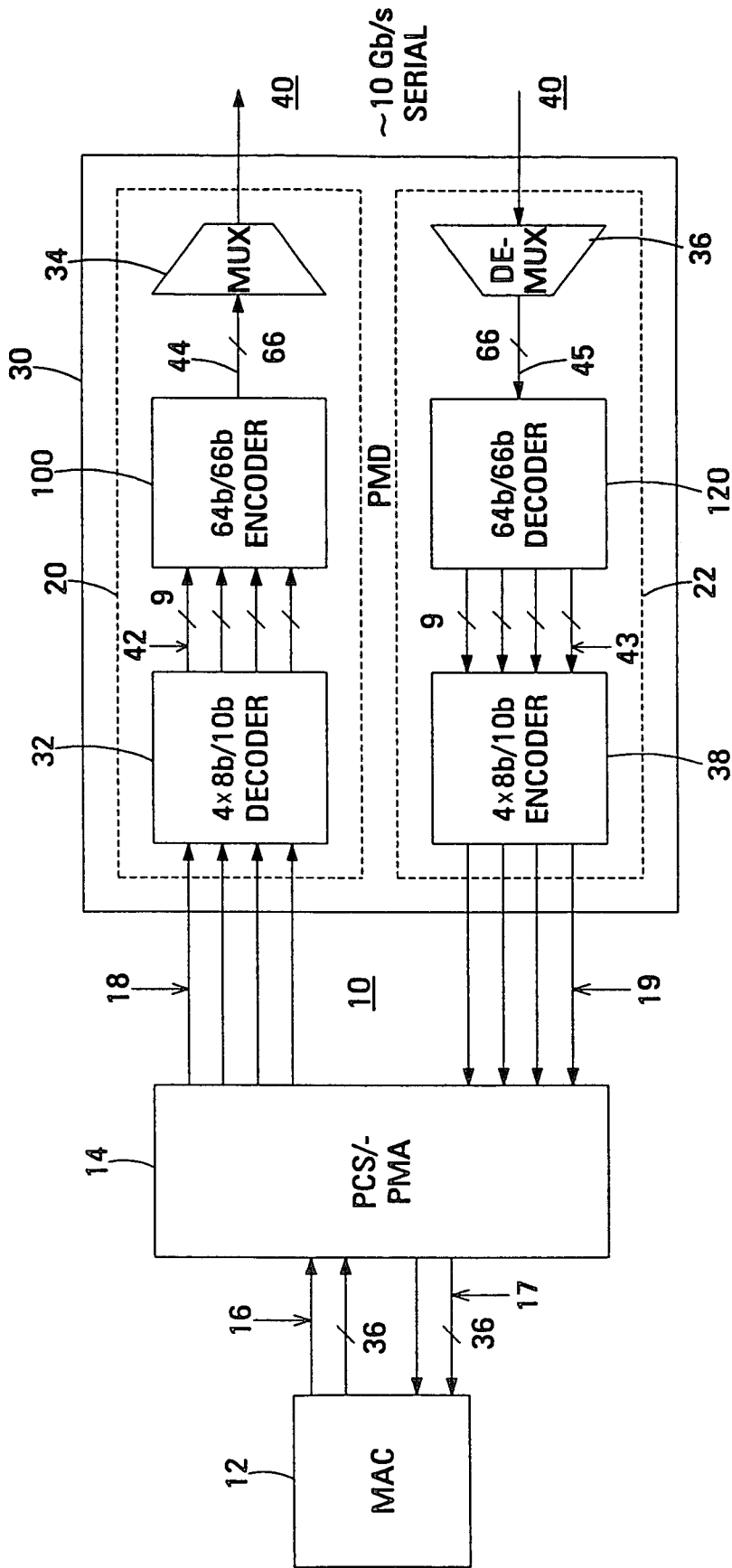

FIG.1

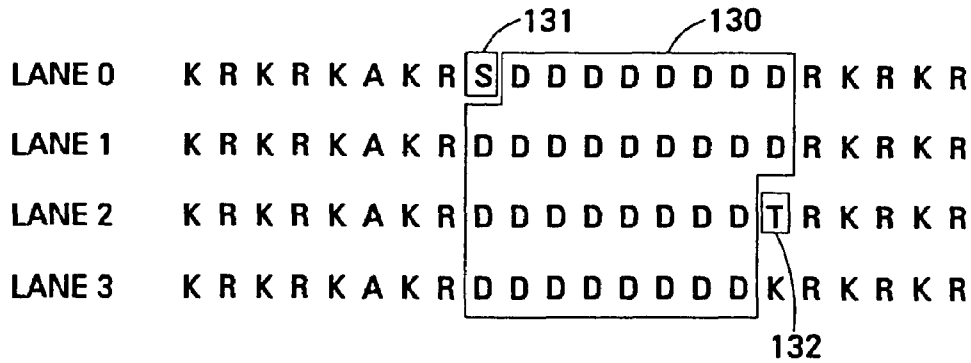

FIG.2

	INFO ONLY	CTRL ONLY	2 PACKET STARTS	
LANE 0	D D	Z Z	S D	Z S
LANE 1	D D	Z Z	D D	Z D
LANE 2	D D	Z Z	D D	Z D
LANE 3	D D	Z Z	D D	Z D
BLOCK TYPE	1	2	3	4

FIG.3A

FIG.3B

FIG.3C

	8 PACKET ENDINGS							
LANE 0	T Z	D Z	D Z	D Z	D T	D D	D D	D D
LANE 1	Z Z	T Z	D Z	D Z	D Z	D T	D D	D D
LANE 2	Z Z	Z Z	T Z	D Z	D Z	D Z	D T	D D
LANE 3	Z Z	Z Z	Z Z	T Z	D Z	D Z	D Z	D T
BLOCK TYPE	5	6	7	8	9	10	11	12

FIG.3D

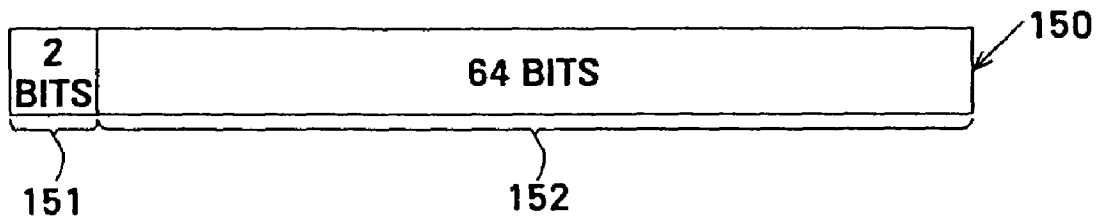

FIG. 4A

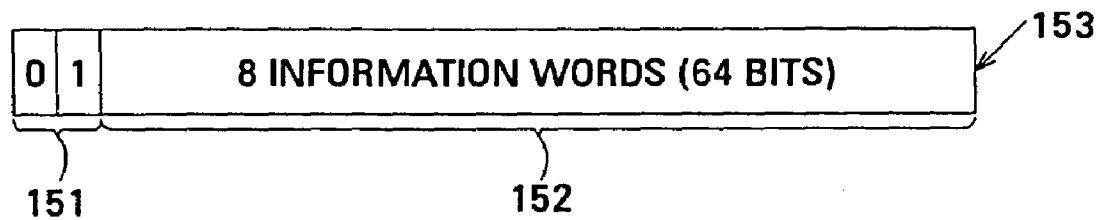

FIG. 4B

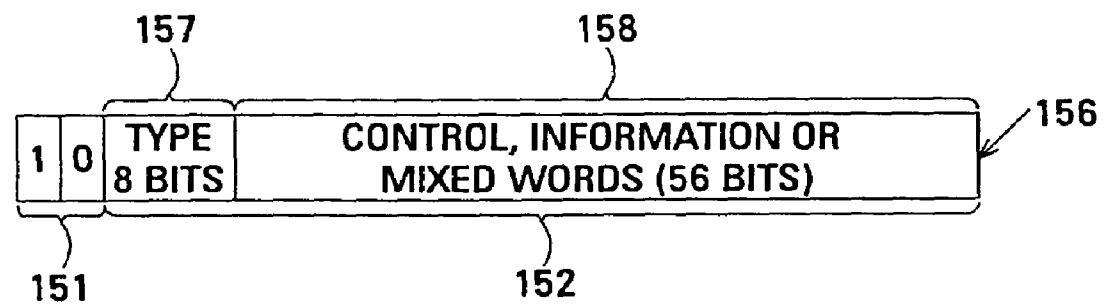

FIG. 4C

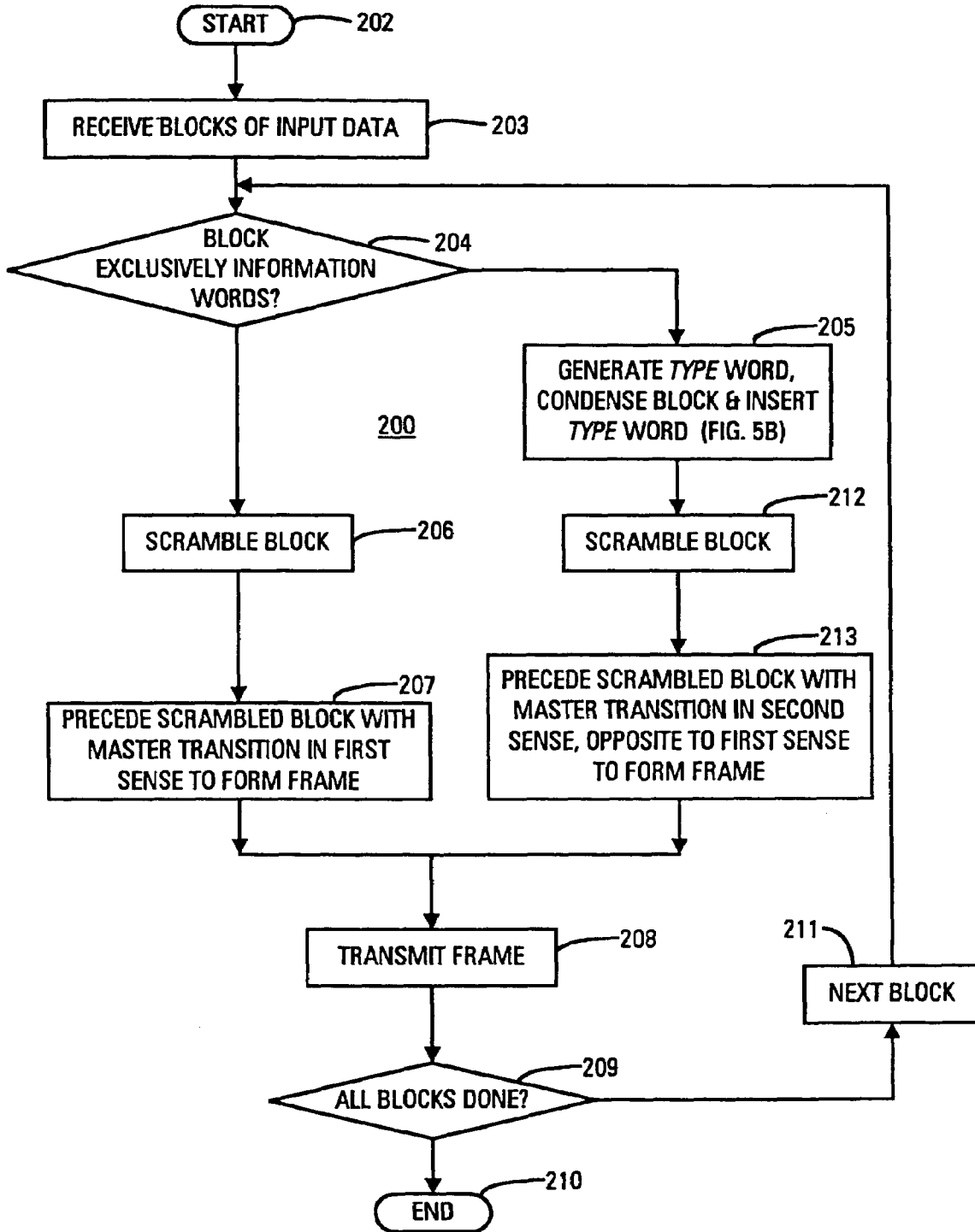

FIG. 5A

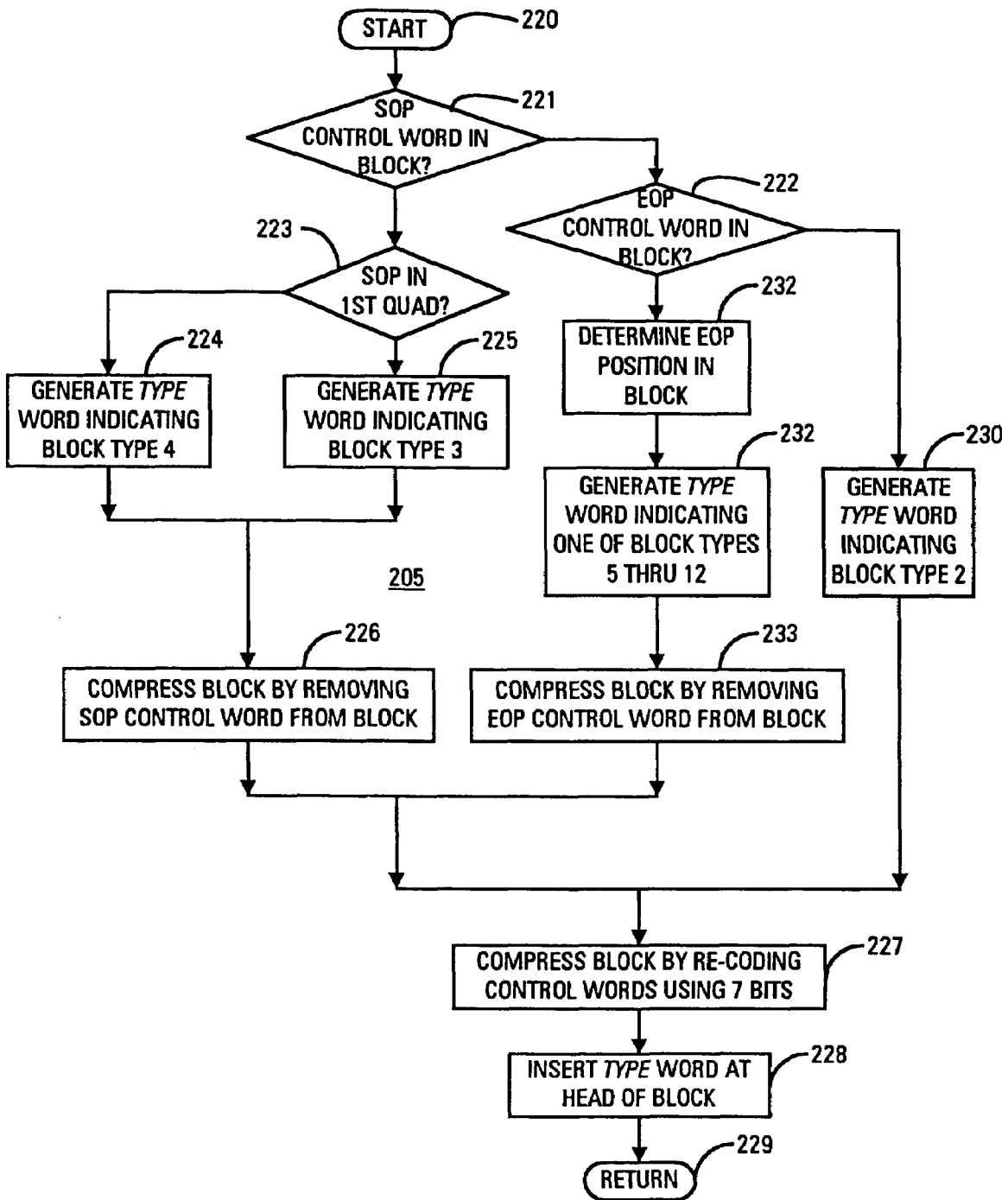

FIG. 5B

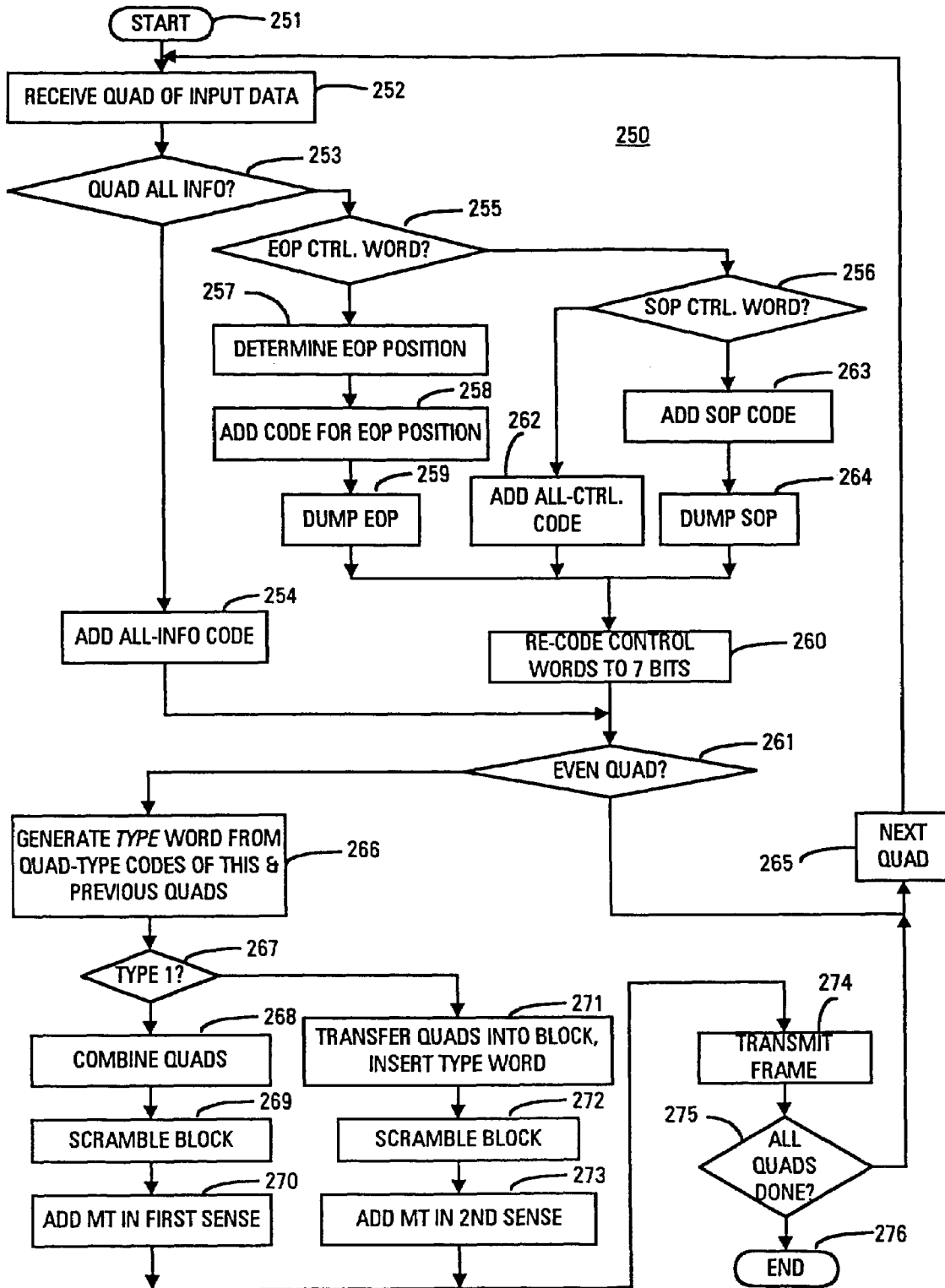

FIG. 6

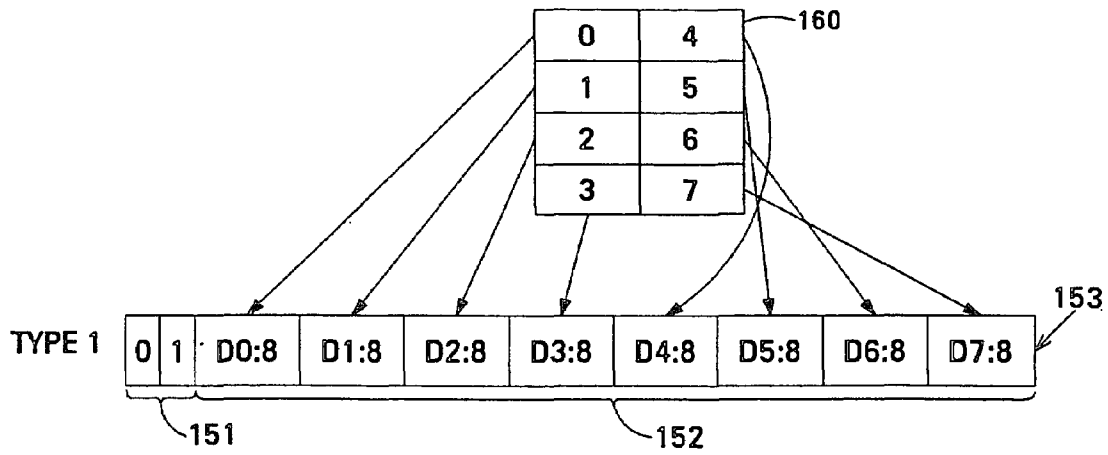

FIG. 7A

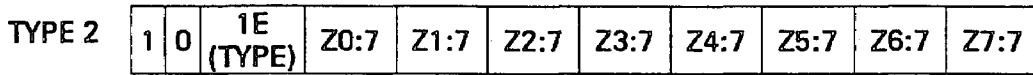

FIG. 7B

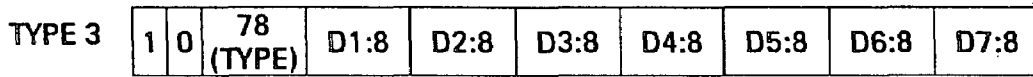

FIG. 7C

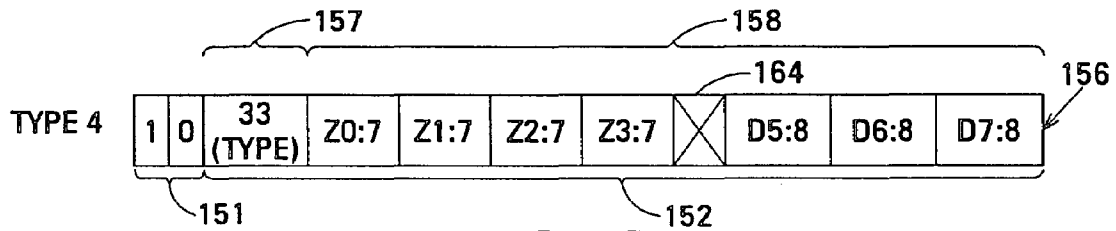

FIG. 7D

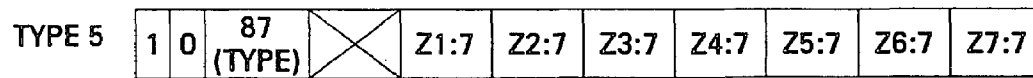

FIG. 7E

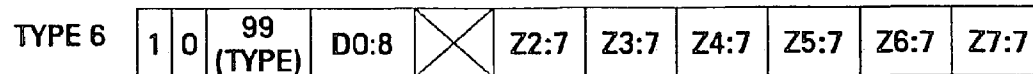

FIG. 7F

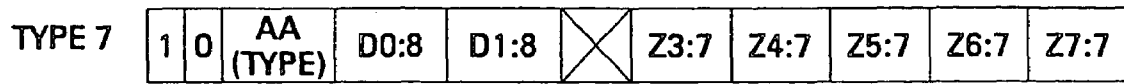

FIG. 7G

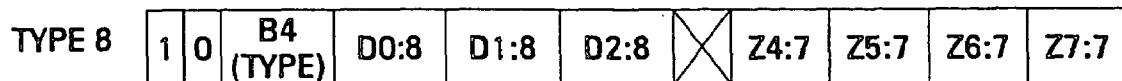

FIG. 7H

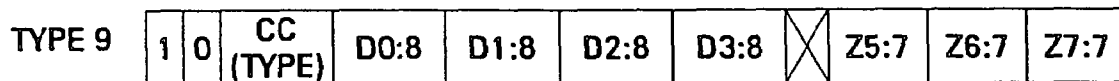

FIG. 7I

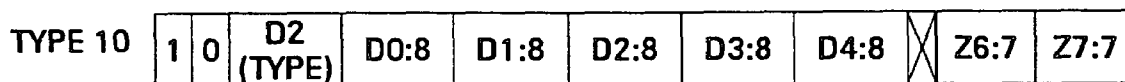

FIG. 7J

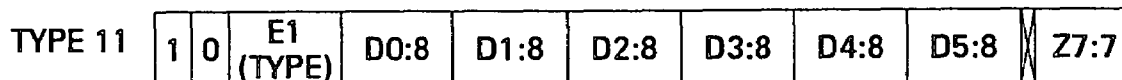

FIG. 7K

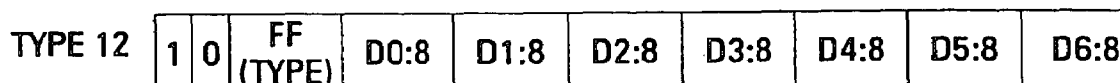

FIG. 7L

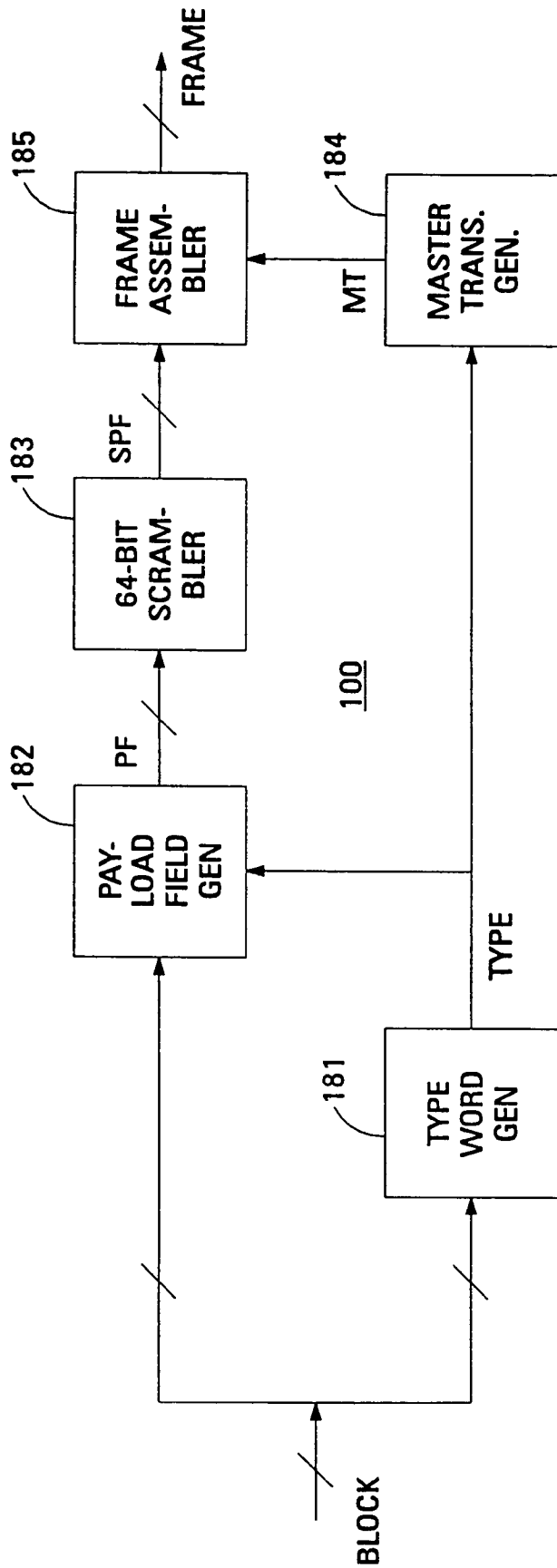

FIG. 8A

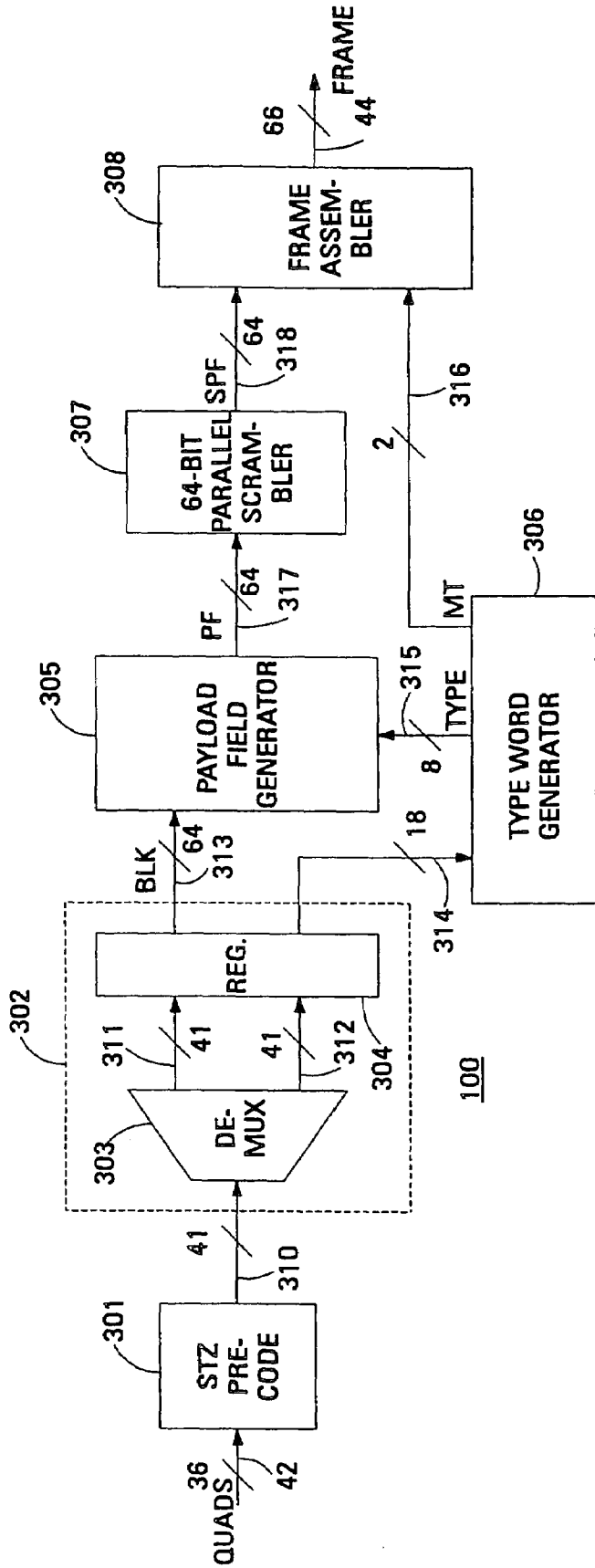

FIG. 8B

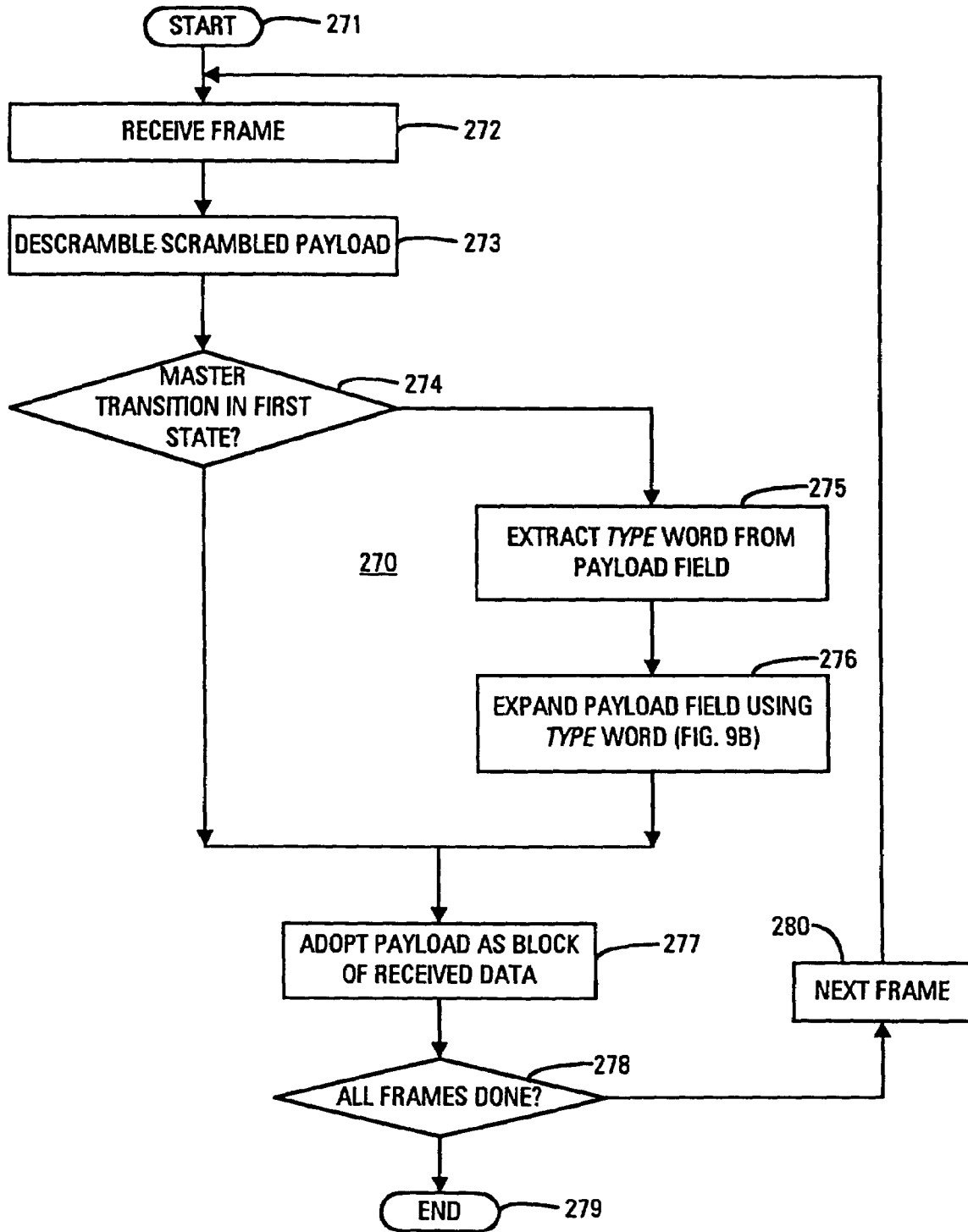

FIG. 9A

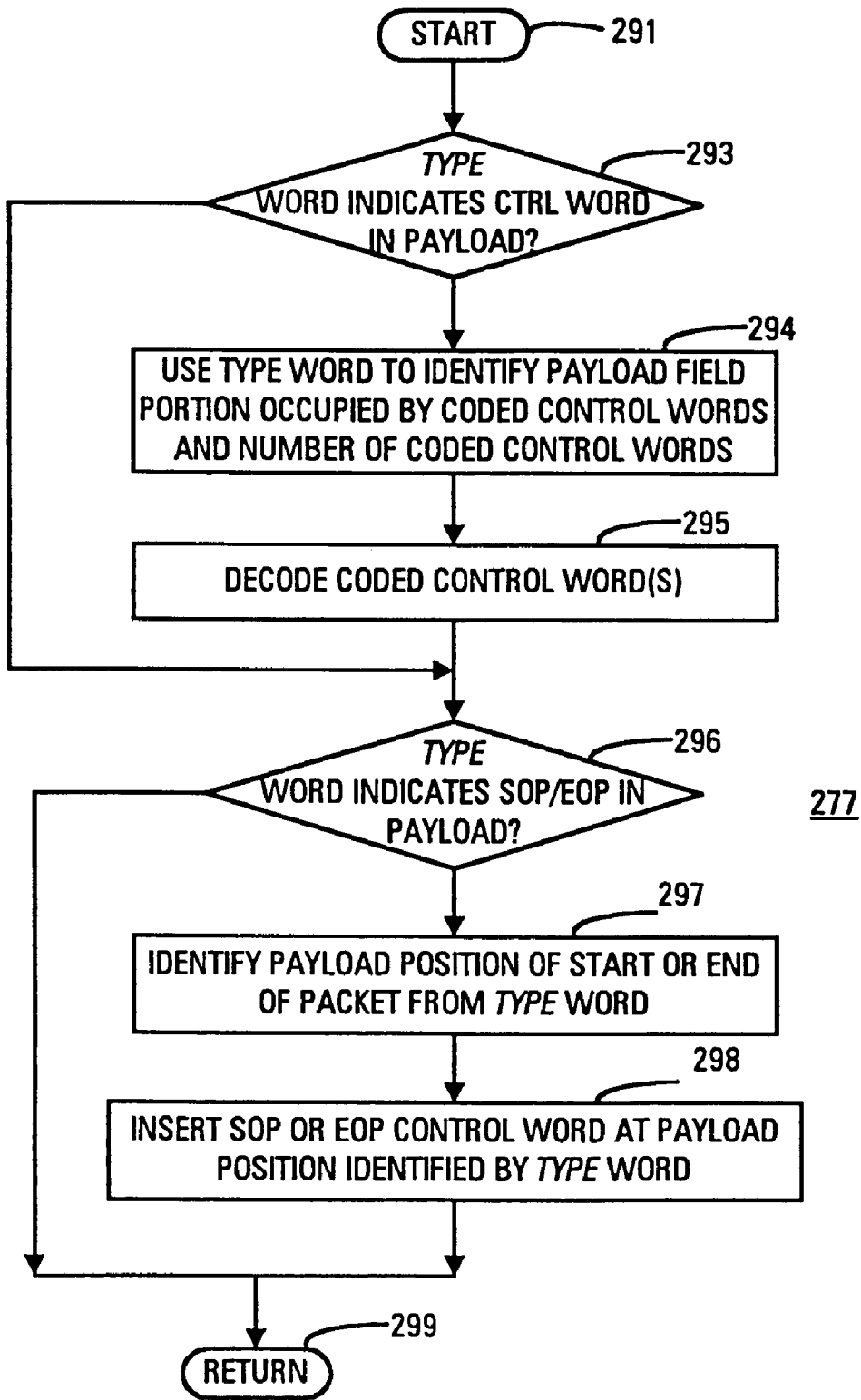

FIG. 9B

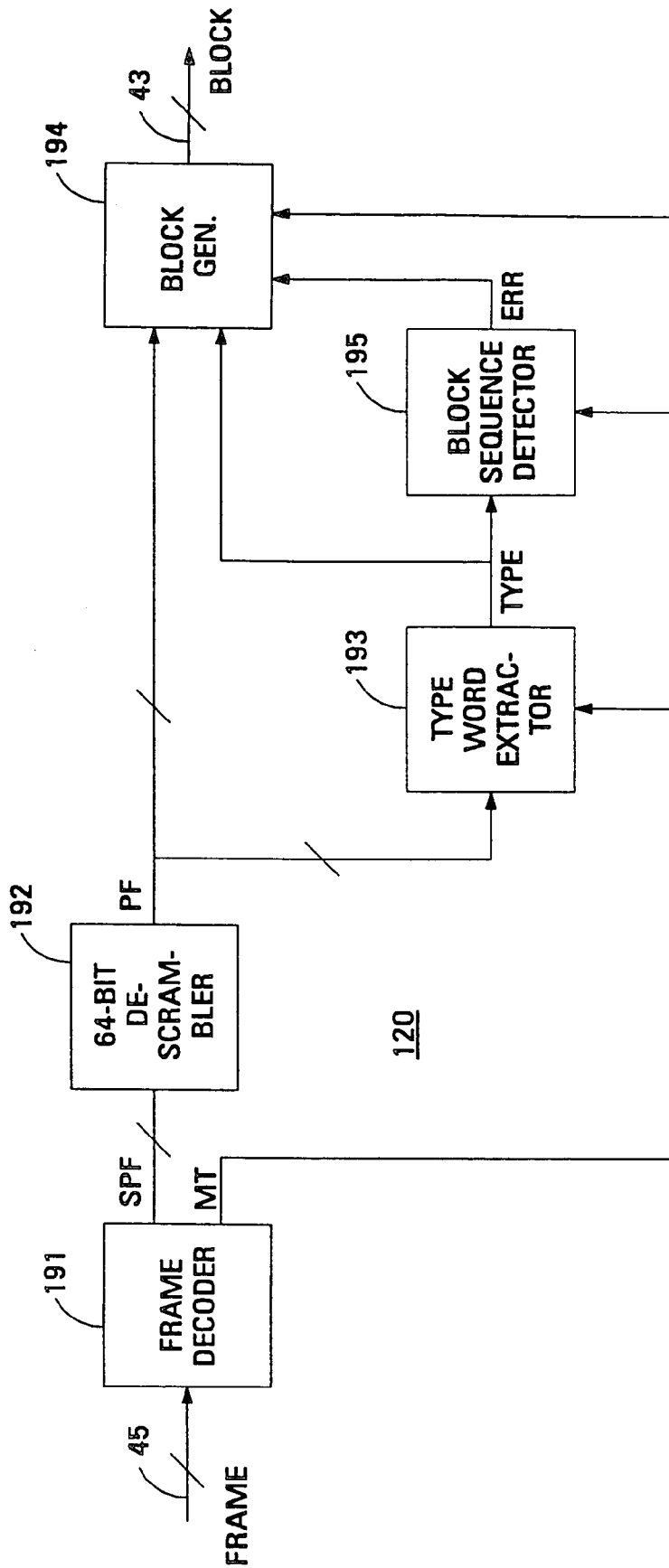

FIG. 10A

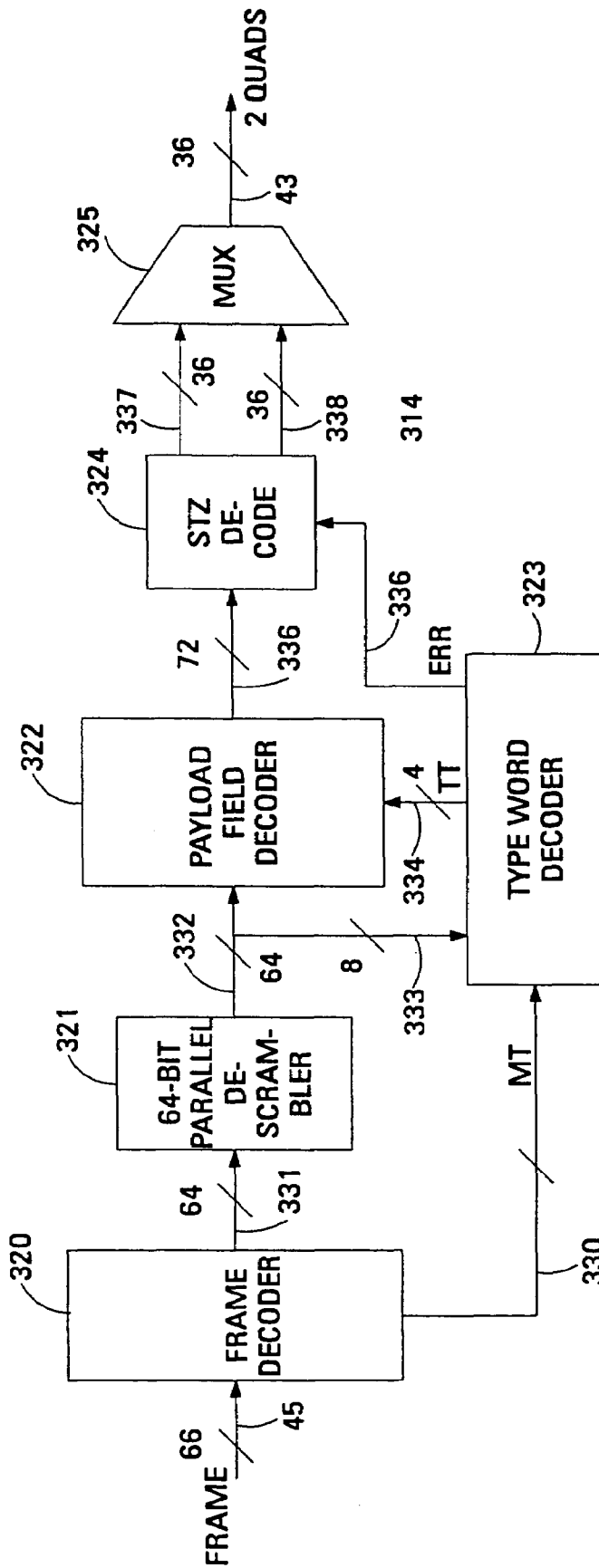

FIG. 10B

**CODING METHOD FOR CODING
PACKETIZED SERIAL DATA WITH LOW
OVERHEAD**

PRIOR APPLICATION

This application is a Continuation of U.S. patent application Ser. No. 09/522,782 filed Mar. 6, 2000, now U.S. Pat. No. 6,718,491, the entire disclosure of which is incorporated herein by reference.

FIELD OF THE INVENTION

The invention relates to coding packetized data for serial transmission, and, in particular, to coding packetized data with an overhead sufficiently low to enable serial transmission through an Ethernet local area network with a bit rate of 10 gigabits/second (Gb/s) using an OC192 SONET laser operating at 10.3 Gb/s.

BACKGROUND OF THE INVENTION

For several decades now, integrated circuit and laser technologies have doubled in performance approximately every 18 months. These technologies have been used to support a rapidly-growing demand for global communications capacity. This demand is currently growing much faster than the underlying rate of improvement of the supporting technologies. As an example, communication traffic through the Internet has recently been doubling every nine months. The demand for additional current bandwidth is severely stressing the capabilities of current electronic and optical technologies.

In particular, the Ethernet local area network standard has progressively increased in speed by factors of ten, starting at 10 megabit per second (Mb/s) in 1982. Proposals for a 10 gigabit/second (Gb/s) Ethernet standard were made in 1999. The most recently adopted Ethernet standard used a 8b/10b line code described by A. X. Widmer and P. A. Franaszek in *A DC-Balanced, Partitioned-Block, 8b/10b Transmission Code*, 27 IBM J. RES. AND DEV., (1983 September) for transmitting serial data at 1 Gb/s. In 8b/10b line code, each eight-bit input word is represented by a ten-bit code that is transmitted on the data link. In exchange for this 25% overhead, 8b/10b coding provides DC balance, and a guaranteed transition density. The ten-bit code additionally has the ability to represent an assortment of control words used for signalling and framing.

Re-using 8b/10b coding for sending information at 10 Gb/s was considered in the proposed 10 Gb/s Ethernet standard. However, using this technique would result in having to transmit at a baud rate of 12.5 Gbaud, i.e., 12.5 Gb/s.

With currently-available laser fabrication technology, manufacturing a laser capable of modulation at 12.5 Gb/s at a modest price is considered to be quite difficult. However, laser systems currently exist for use in systems conforming to the OC-192 SONET telecommunications standard. Such systems operate at signalling rates of 9.95328 Gb/s. However, these commercially-available lasers do not have enough performance margin to run at more than 25% faster than their design speed.

One way to enable the lasers designed for use in SONET telecommunications systems to be used in the proposed 10 Gb/s Ethernet standard would be to design a simple and robust coding scheme with a lower overhead than 8b/10b line code. In principle, this goal can be achieved using a

block code in which words of M bits are represented by an N-bit code and in which the ratio of N:M is less than 10:8.

A potential coding scheme having a lower overhead than 8b/10b line code is that used in the SONET telecommunications standard. The SONET coding scheme assures DC balance by using a scrambling system, and has an overhead of about 3%. However, the scrambling system used in the SONET coding scheme uses two layers of polynomial scrambling to achieve an adequate level of protection. This two-layer scheme is complex to implement. Moreover, the SONET coding scheme has a complex framing protocol that is difficult to implement at low cost. The SONET coding scheme would also have to be modified to add an extra level of encoding to support Ethernet packet delimiting. Such an extra level of coding would probably increase the overhead of the SONET coding to 7% or more. In addition, it is thought that the networking community would find the wholesale adoption of a telecommunications standard to be unpalatable. The performance and political difficulties just described would make it difficult for a standard based on the SONET coding scheme to be adopted as a new Ethernet standard.

Another potential coding scheme having a lower overhead than 8b/10b line code is that known as CIMT. This coding scheme is described in U.S. Pat. No. 5,022,051 of Crandall et al. and U.S. Pat. No. 5,438,621 of Hornak et al. The CIMT code is an (M)b/(M+4)b code that can be configured have a lower overhead than 8b/10b line code by making the value of M sufficiently large. However, for large values of M, the CIMT code is difficult to implement due to the need to compute the DC balance of an incoming block of M bits, and the need to compute a running DC balance of the transmitted bits in real time.

Thus, what is required is a method and apparatus for efficiently coding input data that has a lower overhead than 8b/10b line code and in which the integrated circuit die size and power dissipation are minimized. The method and apparatus should meet the performance requirements of the new Ethernet standard with respect to DC-balance, run-length control and error detection, and should support the non-data, control words such as idle, start-of-packet, end-of-packet, align and error that are required for Ethernet packet delimiting.

SUMMARY OF THE INVENTION

The invention provides coding methods for coding packetized serial data. In a first aspect, blocks of input data are received. The input data comprises packets of information words. The packets are preceded and followed by control words. A master transition is appended to the beginning of each block to form a respective frame for transmission. The master transition has a sense that depends on whether the block contains any control words. Additionally, for each block that contains one or more control words, a TYPE word indicating a structural property of the block is generated, the block is condensed to accommodate the TYPE word, and the TYPE word is inserted into the block.

The structural property represented by the TYPE word includes the position of the start of the packet in the block, the position of the end of the packet in the block, or the block being composed exclusively of control words.

In a second aspect, 64-bit blocks of input data are received. The input data comprises packets of information words. The packets are preceded and followed by control words. A 2-bit master transition is appended to the beginning of each block to form a respective 66-bit frame for trans-

mission. The master transition has a sense that depends on whether the block contains any control words. Additionally, for each block that contains one or more control words, an 8-bit TYPE word indicating a structural property of the block is generated, condensing the block to 56 bits to accommodate the TYPE word, and inserting the TYPE word into the block.

The coding method according to the invention provides a very low overhead when implemented as a 64b/66b code (3.125%). The overhead is substantially lower than 8b/10b (25%). This low overhead enables the coding method according to the invention to transmit Ethernet data at a bit rate of 10.0 Gb/s using existing lasers designed for use in SONET OC-192 transmitters. Thus, adoption of a 10 Gb/s Ethernet standard based on the coding method according to the invention does not have to wait for lasers capable of modulation at 12.5 Gbaud to be developed.

BRIEF DESCRIPTION OF THE DRAWINGS

FIG. 1 is a block diagram showing an example of a 10 Gb/s Ethernet interface including a coder that performs embodiments of a coding method according to the invention.

FIG. 2 schematically shows exemplary quads of the input data received by the coder shown in FIG. 1.

FIGS. 3A–3D show the twelve possible types of blocks that can be received by the coder shown in FIG. 1.

FIGS. 4A–4C show the basic structure and the two kinds of frame that the coder generates from a block of input data.

FIG. 5A is a flow chart showing a first embodiment of a coding method according to the invention.

FIG. 5B is a flow chart showing an example of the processing performed in process 205 of the method shown in FIG. 5A.

FIG. 6 is a flow chart showing a second, quad-based embodiment of a coding method according to the invention.

FIGS. 7A–7L show specific examples of the frames generated from each of the twelve block types shown in FIGS. 3A–3D, including the master transition and the TYPE word, where used.

FIG. 8A is a block diagram showing an embodiment of a coder that performs the first embodiment of the coding method according to the invention.

FIG. 8B is a block diagram showing an embodiment of a coder that performs the second, quad-based embodiment of the coding method according to the invention.

FIG. 9A is a flow chart showing an example of a decoding method for decoding the frames generated by the coding method according to the invention.

FIG. 9B is a flow chart showing an example of the processing performed in process 276 of the method shown in FIG. 9A.

FIG. 10A is a block diagram showing a first embodiment of a decoder for decoding the frames generated by the coding method according to the invention.

FIG. 10B is a block diagram showing a second embodiment of a decoder for decoding the frames generated by the coding method according to the invention.

DETAILED DESCRIPTION OF THE INVENTION

FIG. 1 is a block diagram showing an example of a 10 Gb/s Ethernet interface 10 including the physical medium dependent module (PMD) 30 that includes the encoder 100 that performs an embodiment of a coding method according to the invention. The interface 10 is composed of the

medium access controller (MAC) 12, the physical code layer/physical medium attachment module (PCS/PMA) 14 and the PMD 30. The MAC sends data including user data received from the host system (not shown) to the PCS/PMA via the 37-conductor XGMII bus 16. The MAC additionally receives data that include user data from the PCS/PMA via the 37-conductor XGMII bus 17 for supply to the host system.

The PCS/PMA 14 sends a coded serial bitstream, to be described below, to the PMD 30 via the 4-lane XAUI bus 18 and receives a coded serial bitstream from the PMD via the 4-lane XAUI bus 19.

The physical medium dependent module (PMD) 30 includes the transmission path 20 and the reception path 22. The transmission path 20 is composed of a serial arrangement of the 4×8b/10b decoder 32, the encoder 100 and the multiplexer 34. The input of the 4×8b/10b decoder is connected to one output of the PCS/PMA 14 by the XAUI bus 18. The output of the 4×8b/10b decoder is connected to the input of the encoder by the 37-conductor pseudo-XGMII bus 42.

The output of the encoder 100 is connected to the input of the multiplexer 34 by the bus 44. In one embodiment, the bus 44 is 66 conductors wide, but the encoder and the multiplexer may be configured to use a bus that is substantially narrower than this. The output of the multiplexer is a serial bitstream that is fed to the Ethernet medium 40.

The reception path 22 is composed of a serial arrangement of the demultiplexer 36, the decoder 120 and the 4×8b/10b encoder 38. The demultiplexer receives a serial bitstream from the Ethernet medium 40.

The output of the demultiplexer 36 is connected to the input of the decoder 120 by the bus 45. In one embodiment, the bus 45 is 66 conductors wide, but the demultiplexer and the decoder may be configured to use a bus substantially narrower than this. The output of the decoder is connected to the input of the 4×8b/10b encoder by the 37-conductor pseudo-XGMII bus 43. The output of the 4×8b/10b encoder is connected to one input of the PCS/PMA 14 by the XAUI bus 19.

In the Ethernet interface 10, the MAC 12 receives user data from, and provides user data to, a host system (not shown). The MAC takes any number of words of user data between 64 and 1500, adds 22 words of address and other data to the front of the user data and four words of a CRC-32 checksum to the end of the user data to form a packet. In this disclosure, the contents of a packet will be called information words.

The MAC additionally generates a Start of Packet (SOP) control word S that it adds to the start of each packet to mark the start of the packet. The MAC additionally generates an End of Packet (EOP) control word T that it adds to the end of each packet to mark the end of the packet. The MAC also generates additional control words and inserts them between consecutive packets to generate a continuous stream of words for transmission to the PCS/PMA 14. The continuous stream is required to maintain receiver phase alignment. The additional control words include Idle_even_not_busy K, Idle_even_busy Kb, Idle_odd_not_busy R, Idle_odd_busy Rb, Align A and Error E. This disclosure uses the letter Z as a generic term to indicate any one of the control words.

The MAC 12 feeds the continuous stream of words to the PCS/PMA 14 via the XGMII bus 16. Of the 37 conductors in each of the XGMII buses 16 and 17, 32 are allocated to four, parallel, eight-bit words; four are allocated to control word flags, each of which indicates whether a respective one of the four words is an information word or a control word;

and one is allocated to a clock signal. A set of four eight-bit words transported in parallel by the XGMII busses **16** and **17** and by the pseudo-XGMII busses **42** and **43** will be referred to as a quad.

In addition, the MAC **12** receives from the PCS/PMA **14** via the XGMII bus **17** a continuous stream of quads. The quads are composed of information words arranged in packets and code words interspersed between consecutive packets, as just described. The start and end of each packet are marked with an SOP and an EOP control word, respectively. The MAC extracts the packet of information words from the stream of quads received from the PCS/PMA using the control word flags received in parallel with the quads to indicate the information words. The MAC also checks the validity of each packet using the CRC-32 checksum that constitutes the last four words of the packet. The MAC then extracts the user data from the packet, and forwards the user data to the host system (not shown).

The PCS/PMA **14** receives the continuous stream of quads from the MAC **12**. The MAC and the PCS/PMA are elements of conventional Ethernet system. Consequently, the PCS/PMA module applies 8b/10b line code to each word in the quads received from the MAC. Each word is coded in response to its respective control word flag so that information words and control words having the same eight-bit code are represented by different ten-bit codes. The PCS/PMA also serializes the 10-bit line code words and feeds them to the input of the PMD **30** via the XAUI bus **18**. The XAUI bus is standardized for 10 Gb/s Ethernet and is composed of four parallel conductors, called lanes, each of which carries serial 10-bit line code words at a bit rate of 3.125 Gb/s. Thus, the four conductors constituting the XAUI bus collectively transfer the serial 10-bit line code words to the PMD **30** at an effective bit rate of 12.5 Gb/s.

The XAUI busses **18** and **19** use four parallel conductors to achieve a total bit rate of 12.5 Gb/s because 3.125 Gb/s represents the fastest rate at which data can be reliably transmitted over the conductors of a printed circuit board using present-day technology.

The PCS/PMA **14** also receives four serial bitstreams from the PMD **30** via the XAUI bus **19**. The PCS/PMA parallelizes the bitstreams, decodes the 8b/10b coding of the 10-bit line code words constituting the bitstream, and feeds the resulting continuous stream of quads composed of information words and control words to the MAC **12** via the XGMII bus **17**. The PCS/PMA additionally feeds a control word flag for each of the words constituting the quads to the MAC via the XGMII bus.

In the transmission path **20** of the PMD **30**, the 4×8b/10b decoder **32** is connected to the XAUI bus **18** to receive incoming serial 10-bit line code words at a bit rate of 4×3.125 Gb/s. The 4×8b/10b decoder decodes the 8b/10b coding of the 10-bit line code words to recover respective 8-bit words, and generates, for each word, a word type bit that indicates whether the word is an information word or a control word. The 4×8b/10b decoder feeds quads of the 8-bit words and their respective control word flags to the encoder **100** via the pseudo-XGMII bus **42**. The pseudo-XGMII bus has the same structure as the XGMII bus **16**, but is called pseudo-XGMII in this disclosure to indicate that this bus does not form part of the proposed 10 Gb/s Ethernet standard. The pseudo-XGMII bus is composed of 37 conductors. Thirty-two of the conductors are allocated to the quads, four of the conductors are allocated to the control word flags for the quads, and one conductor is allocated to a clock signal.

It might appear that a substantial simplification could be achieved by omitting the PCS/PMA **14**, the XAUI busses **18**

and **19**, the 4×8b/10b decoder **32** the 4×8b/10b encoder **38** and the pseudo-XGMII busses **42** and **42**, and simply connecting the encoder **100** and the decoder **120** to the MAC **12** via the XGMII busses **16** and **17**. However, the PCS/PMA imposes the rule, described below, that the start-of-packet (SOP) control word can appear only in lane **0** of the XAUI bus, and, hence of the pseudo-XGMII bus. Without this rule, the number of block types would exceed the number that can be represented by a set of eight-bit TYPE words having a mutual Hamming distance of four bits. Moreover, the maximum transmission distance of current embodiments of the XGMII bus is of the order of 100 mm, whereas that of the XAUI bus is of the order of 1 m. Thus, the above-described simplification can be made, but only if the MAC **12** is re-configured to locate the SOP control word exclusively on the lane of the XGMII bus equivalent to lane **0** of the XAUI bus, and the length of the XGMII bus is less than the maximum transmission distance of such bus.

The encoder **100** receives the quads from the pseudo-XGMII bus **42** as input data, encodes consecutive pairs of the quads to generate respective 66-bit packets, as will be described in more detail below, and feeds the packets to the multiplexer **34** via the bus **44**.

The multiplexer receives the 66-bit packets, serializes them and transmits them to the Ethernet medium **40** at a bit rate of 10 Gb/s. Typical transmission ranges are 5 m using RG-174 coaxial cable, 10 m using 5 mm coaxial cable and 40 km using optical fibers.

In the reception path **22** of the PMD **30**, the demultiplexer separates the serial data received at a bit rate of 10 Gb/s from the Ethernet medium **40** into 66-bit packets, and feeds the packets to the decoder **120** via the bus **45**. The decoder decodes the 66-bit packets to generate two consecutive quads of eight-bit words and a control word flag for each word. The decoder transfers the quads and their respective control word flags in parallel to the 4×8b/10b encoder **38** via the pseudo-XGMII bus **43**.

The 4×8b/10b encoder **38** applies 8b/10b encoding to the quads received via the pseudo-XGMII bus **43**, operating in response to the control word flag for each word constituting the quads. The 4×8b/10b encoder transfers the resulting 10-bit line code words via the XAUI bus **19** to the PCS/PMA module **14** at a bit rate of 12.5 Gb/s. The 10-bit line code words are processed by the PCS/PMA and the MAC **12** to provide the received user data to the host system (not shown), as described above.

The 64b/66b coding applied by the encoder **100** will now be described with reference to FIGS. **2**, **3A–3D** and **4A–4C**.

FIG. **2** schematically shows exemplary quads of the input data received by the encoder **100** via the four lanes of the pseudo-XGMII bus **42**. The input data include the exemplary packet **130** composed of information words D. To simplify the drawing, the number of information words in the packet **130** is substantially fewer than the minimum number of information words in a standard Ethernet packet.

Prior to the start of the packet **130**, the encoder **100** receives control words on all four input lanes of the pseudo-XGMII bus **42**. The control words in the four lanes alternate between K and R. A set of alignment characters A that can be used to synchronize the lanes is also shown. The start of the packet **130** is indicated by the SOP control word S, shown at **131**. The SOP control word always appears in lane **0** and never appears in any other lane. If the SOP control word appears in a lane other than lane **0**, this indicates an error and the packet is filled with error codes E.

The information words D constituting the packet **130** are then consecutively received, followed by the EOP control

word T, shown at **132**. The EOP control word can appear in any of the lanes of the pseudo-XGMII bus **42**. The lane in which the EOP control word appears depends on the number of information words in the packet. The packet can be composed of any number of information words between 64 and 1500. The minimum number of control words between consecutive packets is 12. Following the EOP control word **131**, the encoder **100** receives control words that alternate between K and R via all four lanes of the pseudo-XGMII bus. The control words continue until the SOP control word (not shown) indicating the start of the next packet.

The encoder **100** applies 64b/66b encoding to blocks composed of two quads of the input data consecutively received from the pseudo-XGMII bus **42**, i.e., the 64b/66b coding is applied to a total of 64 received bits. Thus, the 64b/66b coding uses 66 bits to represent the 64 received bits. The 64b/66b coding adds a master transition composed of two bits to the start of the block to form a frame. The master transition serves both as a reference for frame synchronization and as a flag that indicates when the frame is composed exclusively of information words. The 64b/66b coding has a coding efficiency of 64/66, or an overhead of 3.125%. The 64b/66b coding results in a transmitted bit rate that is within 4% of the specified bit rate of existing lasers designed for use in SONET transmitters. The inventors believe that this transmitted bit rate is within the normal manufacturing performance window for such existing lasers.

Since each word received from the pseudo-XGMII bus **42** can be either a control word or an information word, as indicated by the word's respective control word flag, also received from the pseudo-XGMII bus, a fully-general code would need to transmit the control word flag for each word to tell the receiver what type of word is being received. The maximum efficiency of such a code would be 8/9, or a 12.5% overhead. The 64b/66b coding achieves a substantially lower overhead than this by taking advantage of features of the XAUI interface and the Ethernet packet structure that reduce the number of possible ways in which information words and control words can be arranged in the input data.

First, each packet of information words received by the encoder **100** is composed of at least 64 words, always starts with the SOP control word S and always ends with the EOP control word T, and consecutive packets are separated by at least 12 control words. This means that when blocks of eight words (64 bits) of the input data are coded, each block can contain information words exclusively, control words exclusively, a single transition from control words to information words or a single transition from information words to control words. As noted above, the master transition that constitutes the first two bits of the frame operates as a flag to indicate when the frame is composed exclusively of information words. This means that, instead of including eight control word flags in each frame to indicate whether the eight words constituting the frame are each an information word or a control word, this number of bits can be used to represent a TYPE word that is included in all frames that are not composed exclusively of information words. Different values of the TYPE word indicate one of the following structural properties of the block: 1) whether the block from which the frame is derived is composed exclusively of control words, 2) the position of the start of a packet in the block from which the frame was derived and 3) the position of the end of a packet in the block from which the frame was derived. Since the number of states represented by the eight-bit TYPE word is relatively small, TYPE words having a large mutual Hamming distance can be chosen. For

example, the TYPE words can be chosen so that more than three bit errors are required to convert one TYPE word to another.

Second, as noted above, XAUI semantics guarantee that the SOP control word S appears in lane **0** exclusively. This reduces the number of ways in which the packet start can appear in the frame to two, which further reduces the total number of ways in which the start of the packet or the end of the packet can appear in the frame.

Third, the set of control words is sufficiently small (K, Kb, R, Rb, S, T, A, E, . . .) to allow the control words to be coded using fewer than eight bits, and to be coded by a set of codes having a large mutual Hamming distance. The bits saved by coding the control words using fewer than eight bits can then be used to condense the block to enable the frame to accommodate the above-described TYPE word. The codes are chosen to enable the control word coding to be highly resistant to bit errors.

FIGS. 3A–3D show the twelve possible types of blocks that the encoder **100** can receive from the pseudo-XGMII bus **42**. FIG. 3A shows a block generated from two consecutive quads located in the middle of the packet, where both quads consist exclusively of information words. The block composed of two consecutive quads of exclusively information words is called a Type 1 block.

FIG. 3B shows the one block Type that includes two consecutive quads located in the middle of the gap between two consecutive packets, where both quads consist exclusively of control words. The block composed of two consecutive quads of exclusively information words is called a Type 2 block.

FIG. 3C shows the two different block Types in which the start of the packet appears. The start of the packet is indicated by SOP control word S. Because the SOP control word can only appear in lane **0** of the pseudo-XGMII bus, the SOP control word can appear in only two possible locations in the block. The block in which the SOP control word appears in the even-numbered quad is called a Type 3 block, and that in which the SOP control word appears in the odd-numbered quad is called a Type 4 block.

FIG. 3D shows the eight different block Types in which the end of the packet appears. The end of the packet is indicated by the EOP control word T. Because the EOP control word can appear in any one of the four lanes of the pseudo-XGMII bus, the EOP control word can appear in any location in the block. The blocks in which the EOP control word appears as word **1** through **8** of the block (see FIG. 7A) are called Type 5 through Type 12 blocks, respectively.

The 12 different types of blocks are indicated by a code that uses a combination of the master transition and the TYPE word. The 12 types of blocks are divided into two different categories, namely, blocks composed exclusively of information words, i.e., the Type 1 block shown in FIG. 3A, and blocks that include at least one control word, i.e., the Type 2–12 blocks shown in FIGS. 3B–3D.

FIG. 4A shows the basic structure of the frame **150** that the encoder **100** generates from a block of input data. The frame is composed of the two-bit sync. field **151** followed by the 64-bit payload field **152**. The sync. field accommodates the two-bit master transition. The words accommodated by the payload field are scrambled with a long-period, self-synchronous scrambler to maintain the statistical DC balance of the transmitted bitstream, as will be described in more detail below.

The encoder **100** generates two different kinds of frame having the basic structure shown in FIG. 4A, but differing in the structure of their payload fields. The structure of the

payload field depends on whether or not the block from which the frame is generated is a Type 1 block composed exclusively of information words. The structure of the payload field is indicated by the master transition stored in the sync. field. FIG. 4B shows the structure of the frame 153 generated when the block is a Type 1 block. In this, the master transition in the sync field 151 is 01, and the payload field 152 is composed of the eight information words constituting the block, i.e., 64 bits.

FIG. 4C shows the structure of the frame 156 generated when the block is a Type 2 through Type 12 block that includes at least one control word. In this, the master transition in the sync. field 151 is 10, and the payload field 152 is composed of the 8-bit sub-field 157 and the 56-bit sub-field 158. The eight-bit sub-field 157 is occupied by the TYPE word and the 56-bit sub-field 158 is occupied by a condensed version of the block. In particular, all information words included in the block are included unchanged in the sub-field 158. The 56-bit sub-field 158 can accommodate up to seven information words, the maximum number of information words in a block that includes at least one control word. Moreover, the control words S and T, if they appear in the block, are discarded and are not transferred to the sub-field 158. Finally, all remaining control words in the block are re-coded using fewer than eight bits and the re-coded control words are included in the sub-field 158. In the preferred embodiment, the remaining control words are re-coded using seven-bit codes chosen to have a mutual Hamming distance of four bits.

The control words S and T can be omitted from the sub-field 158 because position of the start of the packet or the end of the packet in the frame is indicated by the TYPE word included in the sub-field 157. Omitting the control words S and T allows the payload field 158 to accommodate the TYPE word and all seven information words in full when the block is composed of seven information words and either the SOP control word S or the EOP control word T, as in the Type 3 block shown in FIG. 3C and the Type 12 block shown in FIG. 3D. Re-coding the remaining control words as 7-bit words enables the payload field 158 to accommodate the TYPE word and all eight control words when the block is composed exclusively of control words, as in the Type 2 block shown in FIG. 3B. All other combinations of information words and control words are composed of fewer than 56 bits after the S and T control words have been removed and the remaining control words have been re-coded using fewer bits.

FIG. 5A is a flow chart showing a first embodiment 200 of a method according to the invention for applying 64b/66b coding to input data that include a packet of information data. The processing performed in process 205 of the method will be described in more detail below with reference to FIG. 5B.

The method starts at process 202. In process 203, blocks of the input data are received. The input data include the above-mentioned control words in addition to the packet of information words. The control words precede and follow the packet of information words. The blocks are smaller than the packet. In the preferred embodiment, each block is composed of two successive quads of four parallel words received from the pseudo-XGMII bus 42.

In process 204, a test is performed on a block of the input data to determine whether the block is composed exclusively of information words. In the preferred embodiment, this test can be performed simply by examining the control word flags for the eight words that constitute the block. The control word flags are received together with the words that

constitute the block via the pseudo-XGMII bus 42. Alternatively, the test can be performed by testing the quads as they are received, and deriving the test result for the block from the test results for the quads that constitute the block, as will be described in more detail below with reference to FIG. 6.

When the test result is NO, execution advances to process 205, which will be described below. When the test result is YES, execution advances to process 206, where the block is scrambled.

Execution then advances to process 207, where a frame is formed by preceding the scrambled block with a master transition in the first sense. In the preferred embodiment, the master transition in the first sense is provided by the two bits 01.

Execution then advances to process 208, where the frame is transmitted, and to process 209, where a test is performed to determine whether all the blocks of the input data have been processed. When the test result is YES, execution advance to process 210, where it ends. When the test result is NO, execution returns to process 204 via process 211 so that the next block can be processed.

When the test result in process 204 is NO, this indicates that the block includes at least one control word. Execution advances to process 205, where a TYPE word that identifies the structural properties of the block is generated, the block is condensed and the TYPE word is inserted into the block. The TYPE word indicates one of the following structural properties of the block: 1) whether the block is composed exclusively of control words, 2) the position in the block of the start of the frame and 3) the position of the end of the frame the block. Block Types are described in detail above with reference to FIGS. 3A-3D. The processing performed in process 205 will be described in more detail below with reference to FIG. 5B.

Execution then advances to process 212 where the block is scrambled.

Execution then advances to process 213, where a frame is formed by preceding the scrambled block with a master transition in a second sense, opposite to the first sense. In the preferred embodiment, the master transition in the second sense is provided by the two bits 10.

Execution then advances to process 208, where the frame is transmitted, as described above.

The block is described above as being subject to scrambling in processes 207 and 213. In general-purpose data transportation applications, the block has to be scrambled to ensure that the receiver can synchronize to the master transitions, and decode the packets. However, in data transportation applications in which random data are transported, the scrambling processes 207 and 213 can be omitted. Examples of random data include digital audio signals and compressed data.

FIG. 5B shows an example of the processing performed in process 205. In this process, the block is condensed and a TYPE word indicating the structural properties of the block is inserted into the block. The structure includes the position of the start or the end of the packet in the block, and whether the block is composed exclusively of control words.

Execution starts in process 220. In process 221, a test is performed to determine whether the block includes the SOP control word S that indicates that the packet starts in the block. When the test result is NO, execution advances to process 222, which will be described below. When the test result is YES, execution advances to process 223, where a test is performed to determine whether the SOP control word

appears in the first quad constituting the block. Each block processed by the encoder 100 is composed of two consecutively-received quads.

When the test result generated by process 223 is NO, execution advances to process 224, where a TYPE word indicating that the block is a Type 4 block is generated. A Type 4 block is one in which the SOP control word appears in the second quad. Block types are described in detail above with reference to FIGS. 3A-3D. Execution then advances to process 226, which will be described below. When the test result generated in process 223 is YES, execution advances to process 225, where a TYPE word indicating that the block is a Type 3 block is generated. A Type 3 block is one in which the SOP control word appears in the first quad.

Execution advances from process 224 or process 225 to process 226, where the block is condensed by removing the SOP control word from the block. Condensing the block creates space in the block for the TYPE word generated in process 224 or process 225 to be inserted into the block in process 228, to be described below.

Execution then advances to process 227, where the block is condensed by re-coding any control words in the block using fewer bits. If either process 226 or process 233 has previously been executed, the effect of executing process 227 is to compress the block further. Process 233 will be described below. The purpose of condensing the block is described above. In the preferred embodiment, the 8-bit control words are re-coded using fewer bits. The set of control words is sufficiently small to allow the control words to be coded using 7-bit codes chosen to have a mutual Hamming distance of four bits. The re-coding process can refer to the TYPE word for the block to find the locations of the control words in the block.

Execution then advances to process 228, where the TYPE word is inserted at the head of the block. Space to accommodate the TYPE word has been created in the block by executing one or more of processes 226, 227 and 233. Process 233 is described below.

Execution then advances to process 229, whence it returns to the main routine.

When the test result in process 221 is NO, execution advances to process 222, where a test is performed to determine whether the block includes the EOP control word T that indicates that the end of the packet appears in the block. When the test result is NO, execution advances to process 230, which will be described below. When the test result is YES, execution advances to process 231, where the position of the EOP control word in the block is determined. As shown in FIG. 3D, any of the eight words in the block can be the EOP control word.

Execution then advances to process 232, where a TYPE word is generated in accordance with the position of the EOP control word in the block. The TYPE word indicates that the block is one of a Type 5 through Type 12 block. Type 5 through Type 12 blocks are blocks in which the EOP control word appears in one of the eight word positions in the block, as described above with reference to FIG. 3D.

Execution then advances to process 233, where the block is condensed by removing the EOP control word from the block. The purpose of condensing the block is described above.

Execution then advances to process 227, where the block is further condensed by re-coding any control words remaining in the block are re-coded using fewer bits, as described above.

A test result of NO in process 222 indicates that the block is composed exclusively of control words. In this case,

execution advances to process 230 where a TYPE word indicating that the block is a Type 2 block is generated. A Type 2 block is a block composed exclusively of control words.

Execution then advances to process 227, where the block is condensed by re-coding the control words included in the block using fewer bits, as described above. In this case, all eight words in the block are control words and are re-coded.

Note that in the above processing, such information words as are included in the block remain unchanged.

FIG. 6 is a flow chart showing a second embodiment 250 of a coding method according to the invention for applying 64b/66b coding to input data that include a packet of information data. This embodiment is quad-based rather than block-based. The method starts at process 251. In process 252, a quad of input data is received from the pseudo-XGMII bus 42 shown in FIG. 1. A control word flag for each word in the quad is also preferably additionally received.

In process 253, a test is performed to determine whether the quad is composed exclusively of information words. This test can be performed simply by examining the control word flags of the quad. When the test result is YES, execution advances to process 254, where a quad-type code indicating that the quad is composed exclusively of information words is appended to the quad. Execution then advances to process 261, which will be described below. When the test result is NO, execution advances to process 255.

In process 255, a test is performed to determine whether any of the control words in the quad is the end-of-packet (EOP) control word. When the test result is NO, execution advances to process 256, which will be described below. When the test result is YES, execution advances to process 257, where the position of the EOP control word in the quad is determined, and to process 258, where a quad-type code is appended to the quad. The quad-type code indicates the position of the EOP control word in the quad. In process 259, the EOP control word is removed from the quad. This has the effect of condensing the block of which the quad is a constituent.

In process 260, any other control words in the quad are re-coded using fewer bits, as described above. This has the effect of further condensing the block of which the quad is a constituent. Execution then advances to process 261, which will be described below.

When the test result in process 255 is NO, execution advances to process 256 where a test is performed to determine whether any of the control words in the quad is the start of packet (SOP) control word. When the test result is NO, execution advances to process 262, where a quad-type code indicating that the quad is composed exclusively of control words is appended to the quad. Execution then advances to process 260, described above, where the control words are re-coded, and then to process 261, to be described below.

When the test result in process 256 is YES, execution advances to process 263, where a quad-type code indicating that the SOP control word appears in lane 0 of the quad is appended to the quad.

In process 264, the SOP control word is removed from the quad. This has the effect of condensing the block of which the quad is a constituent.

Execution then advances to process 260, described above, where the control words are re-coded, and then to process 261, to be described next.

In process 261, a test is performed to determine whether the quad just processed is an even-numbered quad. When the test result is YES, execution returns to process 252 via process 265 so that the next quad can be received and processed. In this case, the next quad is the second quad that constitutes the block from which the frame will be generated. A test result of NO indicates that both quads that constitute the block have been received and processed, and execution advances to process 266.

In process 266, the quad-type codes appended to the two quads are examined to determine the block Type of the block that will be generated from the quads, and to generate the TYPE word for the block. For example, when the quad-type code of the even-numbered quad indicates that the SOP control word appears in the quad, and the quad-type code for the odd-numbered quad indicates that the quad is composed exclusively of information words, the process 266 determines that the block is a Type 3 block (see FIG. 3C).

Although TYPE words are allocated only to blocks that include a control word, the processing 250 can be simplified by allocating an additional TYPE word to Type 1 blocks, i.e., blocks composed exclusively of information words. The additional TYPE word is used internally by the processing 250, and is never inserted into the block. For example, the word 00_H can be used as the TYPE word for Type 1 block.

In process 267, a test is performed to determine whether the block is composed exclusively of information words by testing whether the block is a Type 1 block. When the test result is YES, execution advances to process 268, where the quads are combined to form the block.

In process 269, the block is scrambled, as described above. This process may be omitted when the information words are random, as described above.

In process 270, the frame is formed by preceding the scrambled block with a master transition in the first sense. In the preferred embodiment, the master transition in the first sense is provided by the two bits 01.

Execution then advances to process 274, which will be described below.

When the test result generated in process 267 is NO, execution advances to process 271, where the quads are combined to form the block and the TYPE word is inserted. The TYPE word is inserted at the head of the block. In combining the quads, the information words are shifted to abut one another and also to abut either the TYPE word or the end of the block. The coded control words are shifted to abut one another and also to abut either the end of the block or the TYPE word (see FIGS. 7A-7L for examples). Any gap between the information words and the control words is filled with fill bits.

In process 272, the block is scrambled, as described above. Again, this process is optional if the information words are random.

In process 273, the frame is formed by preceding the scrambled block with a master transition in the second sense. In the preferred embodiment, the master transition in the second sense is provided by the two bits 10.

Execution then advances to process 274, which will be described next.

In process 274, the frame is transmitted.

In process 275, a test is performed to determine whether all the quads of the input data have been processed. When the test result is YES, execution advances to process 276, where it ends. When the test result is NO, execution returns to process 252 via process 265, described above, so that the next quad, an even-numbered quad, can be processed.

FIGS. 7A-7L show specific examples of the frames generated from each of the twelve block types shown in FIGS. 3A-3D, including the master transition and the TYPE word, where used. FIG. 7A shows the frame 153 generated from the Type 1 block shown in FIG. 3A. This block is composed exclusively of information words. In the frame 153, the sync field 151 is filled with the two-bit master transition 01 and the payload field 152 is filled with the eight information words located in the eight positions 0 through 7 in the block 160, as shown. Each of the information words in the payload field is labelled with the letter D, a number and the numeral 8. The letter D indicates an information word, the number indicates the location of the information word in the block 162 and the numeral 8 indicates that the information word is composed of eight bits.

FIG. 7B shows a frame generated from the Type 2 block shown in FIG. 3B. FIGS. 7C and 7D respectively show frames generated from the Type 3 and Type 4 blocks shown in FIG. 3C. FIGS. 7E-7L respectively show frames generated from the Type 5 through 12 blocks shown in FIG. 3D. As an example, FIG. 7D shows the frame 156 generated from the Type 4 block shown in FIG. 3C. The Type 4 block is composed partly of control words, i.e., the SOP control word S and the unspecified control words Z, and partly of information words D. In the frame 156, the sync. field 151 is occupied by the two-bit master transition 10 and, in the payload field 152, the sub-field 157 is occupied by the 8-bit TYPE word, in this example, the hexadecimal number 33_H. The TYPE word indicates that the frame is generated from a Type 4 block in which the start of a packet appears in the odd-numbered quad constituting the block. The sub-field 158 of the payload field is occupied by three coded control words Z and three eight-bit information words D.

Each of the data elements in the sub-field 158 is labelled with the letter D or Z, a number and the numeral 7 or 8. The letter D indicates an information word, the letter Z indicates a control word, the number indicates the location of the information word or control word in the block using the convention described above with reference to FIG. 7A, the numeral 7 or 8 indicates the number of bits in the data element, i.e., seven bits for each coded control word and eight bits for each information word. As noted above, the SOP control word S is discarded and is not transferred to the sub-field 158. The function of the SOP control word indicating that the packet starts at position 4 of the block is provided by the TYPE code 33_H instead.

The three coded control words Z coded as 7-bit words and three eight-bit information words D do not fully occupy the sub-field 158 of the frame 156. The unoccupied region 164 of the sub-field is filled with suitable idle bits. Alternatively, functions can be assigned to the bits used to fill the unoccupied portions of the sub-field 158.

The TYPE words illustrated in FIGS. 7B-7L are chosen to have a mutual Hamming distance of four bits to ensure that the start and the end of the packet are reliably identified. The TYPE words are additionally chosen to be easy to generate and to test. The set of chosen TYPE words is an eleven-element sub-set of a 16-element set generated as follows: the first four bits of each successive element in the set increments from 0 to 15 in binary. The second four bits of each element provide the minimum Hamming distance protection and are either 1) a duplication of the first four bits when the parity of the first four bits is even, or 2) the complement of the first four bits when the parity of the first four bits is odd. The 16-element set is optimum in that it provides for a very simple implementation with low gate delay and latency.

At first sight, the two bits constituting the master transition would appear to suffer from the disadvantage that a two-bit error can convert the kind of frame defined by the master transition from a frame that lacks the TYPE word (FIG. 4B) to a frame that includes the TYPE word (FIG. 4C). This is not robust enough to meet Ethernet requirements. However, master transition errors as large as four bits can be detected in the decoder **120** by monitoring the sequencing of the kinds of frame. As noted above, each frame can be one of four different kinds, namely, one composed exclusively of information words D (Type 1), one that includes the start of packet S (Types 3 and 4), one that includes the end of packet T (Types 5–12) and one composed exclusively of control words Z (Type 2). In normal operation, the four different frame types are generated in a predetermined order, namely: S, D, . . . , D, T, Z, . . . , Z, S, D, . . . , D, T, Z, . . . , Z, etc., and must be received in the same predetermined order. By monitoring the order of the kinds of frame received and flagging violations of the predetermined order by adding the error control word E to the decoded data, the MAC **12** can void damaged packets.

FIG. 8A is a block diagram showing a first embodiment of the encoder **100** described above with reference to FIG. 1. The encoder is composed of the type word generator **181**, the payload field generator **182**, the 64-bit scrambler **183**, the master transition generator **184** and the frame assembler **185**.

In the encoder **100**, the type word generator **181** and the payload field generator **182** are connected to receive blocks of input data from the 4×8b/10b decoder **32** via the pseudo-XGMII bus **42** (FIG. 1). The input data are composed of control words and a packet of information words. The packet is preceded and followed by the control words. In the preferred embodiment, the blocks are eight words, i.e., 64 bits, long and are smaller than the smallest size of the packet. The blocks are also smaller than the number of control words between consecutive packets. The encoder processes the input data block-by-block to generate respective frames for transmission.

The type word generator **181** generates a TYPE word whose value indicates one of the following mutually-exclusive structural properties of the block: 1) whether the block is composed exclusively of control words, 2) a position of the start of the packet in the block and 3) a position of the end of the packet in the block and 4) whether the block is composed exclusively of information words. The type word generator feeds the TYPE word to the payload field generator **182** and the master transition generator **184**. The value of the TYPE word that indicates whether the block is composed exclusively of information words may take the form of a flag bit fed to the master transition generator **184** and, optionally, to the payload field generator **182**.

The payload field generator **182** operates in response to the TYPE word. When the TYPE word indicates that the block is composed exclusively of information words, the payload field generator adopts the block to form a payload field. Otherwise, when the TYPE word indicates that the block is not composed exclusively of information words, the payload field generator condenses the block and inserts the TYPE word into the block to form the payload field.

The payload field generator **182** condenses the block by performing one or both of the following operations: 1) removing any start-of-packet control word or an end-of-packet control word from the block, and 2) re-coding any other control words in the block using fewer bits. In the preferred embodiment, the control words are re-coded using seven-bit codes having a mutual Hamming distance of four

bits. Whether the payload field generator simply adopts the block as the payload field, or processes the block further before forming the payload field may be determined by the above-mentioned flag bit in lieu of the full TYPE word. The TYPE word indicates the location in the block of the start-of-packet control word or the end-of-packet control word (if any) and the locations in the block of the other control words (if any).

The payload field generator **182** feeds the payload field PF generated from the block to the 64-bit scrambler **183**.

The 64-bit scrambler **183** is a self-synchronous scrambler based on a high-order polynomial and will be described in more detail below. The scrambler may be omitted in embodiments of the encoder **100** designed exclusively for transmitting input data that is already random, as described above. The scrambler feeds the scrambled payload field SPF it generates from the payload field PF to the frame assembler **185**.

The master transition generator **184** operates in response to the TYPE word, or, alternatively, to the flag bit described above, and generates a master transition. The master transition generator generates the master transition in a first sense when the TYPE word, or flag bit, indicates that the block is composed exclusively of information words. Otherwise, when the TYPE word, or flag bit, indicates that the block is not composed exclusively of information words, the master transition generator generates the master transition in a second sense, opposite to the first sense. In the preferred embodiment, the master transition in the first sense is **01**, and the master transition in the second sense is **10**. Transitions opposite to those shown could alternatively be used. The master transition generator feeds the master transition MT to the frame assembler **185**.

The frame assembler **185** receives the scrambled payload field from the 64-bit scrambler **183** and the master transition from the master transition generator **184** and appends the master transition to the scrambled payload field to form the frame for transmission. The frame assembler preferably locates the master transition before the payload field, but could alternatively locate the master transition after the payload field.

The frame assembler feeds the 66-bit frame to the multiplexer **34** via the bus **44** (FIG. 1).

FIG. 8B is a block diagram showing a second embodiment of the encoder **100** described above with reference to FIG. 1. In this embodiment, the processing is quad based. The encoder is composed of the STZ pre-coder **301**, the block generator **302** composed of the demultiplexer **303** and the register **304**, the payload field generator **305**, the type word generator **306**, the scrambler **307** and the frame assembler **308**.

The STZ pre-coder **301** receives quads of words and their respective control word flags via the pseudo-XGMII bus **42**. The STZ re-coder generates a quad-type code for each quad. The quad-type code is analogous to the above-described TYPE word that indicates the block Type of a block, but pertains to a quad. The quad-type code is a code whose value indicates one of the following mutually-exclusive structural properties of the quad: 1) whether the quad is composed exclusively of information words, 2) whether the quad is composed exclusively of control words, 3) whether the SOP control word appears in the quad, and 4) the position in the quad of the EOP control word (if any). Characteristics 1) and 2) can be detected simply by examining the control word flags.

For each quad that is not composed exclusively of information words, the STZ pre-coder **301** condenses the quad by

re-coding each word, if any, in the quad that is indicated by its control word flag to be a control word. The codes for coding the control words are chosen to have a mutual Hamming distance of four bits. Re-coding the SOP and EOP control words is optional since these control words are later discarded by the payload field generator **305**. The STZ pre-coder additionally appends the four control word flags and the quad-type code to the quad, which may have been condensed, to form a pre-coded quad, and feeds the pre-coded quad to the block generator **302** via the 41-bit wide bus **310**.

The block generator **302** receives consecutive pairs of pre-coded quads from the STZ pre-coder **301** and forms the blocks of eight words from them. In the block generator, the de-multiplexer **303** receives the consecutive pairs of pre-coded quads and switches them alternately to outputs connected to via 41-bit wide busses **311** and **312** to corresponding inputs of the register **304**.

The register **304** outputs the pairs of pre-coded quads in parallel. The pre-coded quads are output in two parts that effectively split the quads from their respective quad-type codes and the control word flags. The pair of quads received by the register form the block BLK that is fed by the 64 bit-wide bus **313** to the frame composer **305**. The pair of quad-type codes and the control words flags corresponding to the block are fed by the 18-bit wide bus **314** to the type word generator **306**.

The type word generator **306** determines the block Type of the block BLK from the pair of quad-type codes for the block received via the bus **314**, generates the corresponding TYPE word and feeds the TYPE word to the payload field generator **305** via the 8-bit bus **315**. For example, when the quad code for the even-numbered quad indicates that the quad is composed exclusively of information words, and the quad code for the odd-numbered quad indicates that the EOP control word T is the third word of the quad, the type word generator generates the TYPE word for a Type 11 block. As another example, when both quad codes indicate that the corresponding quads are composed exclusively of information words, the type word generator generates a special additional value of the TYPE word, such as **00**. This special value of the TYPE word is used only internally within the encoder **100** to indicate that the block is a Type 1 block. This value of the TYPE word is not inserted into the payload field **152** of the frame generated for transmission (see FIG. 4B).

When the type word generator **306** determines that the block is a Type 1 block, it generates the master transition MT in the first state, i.e., **01** in the preferred embodiment, and feeds the master transition to the frame assembler **308** via the 2-bit bus **316**. When the type word generator determines that the block is other than a Type 1 block, it generates the master transition MT in the second state, i.e., **10** in the preferred embodiment, and feeds the master transition to the frame assembler.

When the payload field generator **305** receives from the type word generator **306** the special value of the TYPE word that indicates the block is a Type 1 block, the payload field generator adopts the block received from the block generator **302** via the bus **313** as the payload field **152** of the frame **153** that will be generated from the block (see FIG. 4B). The payload field **152** has a size of 64 bits and is composed exclusively of information words.

When the payload field generator **305** receives from the type word generator **306** a value of the TYPE word that indicates the block is not a Type 1 block, the payload field generator transfers the contents of the block received from the block generator **302** via the bus **313** into the sub-field

158 of the payload field **152** of the frame **156** that will be generated from the block (see FIG. 4C), and inserts the TYPE word into the sub-field **157** of the payload field. In performing this transfer, any start-of-packet control word or end-of-packet control word that appears in the block is not transferred to the payload field to condense the block. When the size of the contents of the block without the SOP or EOP control word, is less than 56 bits, the payload field generator pads the sub-field **158** to 56 bits, as shown in FIG. 7G, for example. This makes the total size of the payload field **152** 64 bits. The payload field generator employs a bank of 64 three-input data selectors that operate in response to the TYPE word to transfer the contents of the block to the payload field.

The payload field generator **305** feeds each payload field PF that it generates to the 64-bit scrambler **307** via the 64-bit bus **317**.

The 64-bit scrambler **307** scrambles the payload field PF received from the payload field generator **305** using a high-order polynomial scrambler, the characteristics of which will be described below. The scrambler may be omitted in embodiments of the encoder **100** designed exclusively for transmitting input data that is already random, as described above. The 64-bit scrambler **307** feeds the scrambled payload field SPF to the frame assembler **308** via the 64-bit wide bus **315**.

The frame assembler **308** appends the master transition MT to the scrambled payload field SPF and feeds the resulting 66-bit frame to the multiplexer **34** (FIG. 1) via the 66-bit wide bus **44**. The master transition is preferably appended to the front of the payload field, but may optionally be appended to the end of the payload field.

The use of self-synchronizing scramblers based on polynomials to scramble bitstreams is known in the art. In the coding method according to the invention, the payload field **152** of each frame **150** (see FIG. 4A) is scrambled so that when the frames are transmitted, the resulting bitstream is statistically DC balanced and additionally appears to be random. Scrambling the payload fields enables the decoder to synchronize easily on the master transitions, which are not scrambled. Choosing the tap spacings of the polynomial to optimize the scrambler for a given application is challenging. In the case of the scrambler for the 10 Gb/s Ethernet coder described above with reference to FIG. 1, the scrambling polynomials are chosen to meet the following requirements:

the chosen polynomial must cause no violations of the Ethernet-standard CRC **32** coding under exhaustive three-error tests with spill-in and spill-out for all packet sizes;

the polynomial tap spacings must be greater than eight to prevent error multiplication from degrading the Hamming distance among the TYPE words; and

the polynomial order should be >57 to prevent malicious jamming and <64 to minimize implementation complexity.

The inventors have identified a polynomial that meets the above criteria, and an additional polynomial that meets most of the criteria: the preferred choice is $x^{58}+x^{19}+x^0$. The alternative choice is $X^{65}+x^{18}+x^0$.

In the preferred embodiment, the blocks are scrambled using a 64-bit, self-synchronizing, parallel scrambler using the preferred polynomial.

FIG. 9A is a flow chart showing an example **280** of a decoding method for decoding the frames generated by the coding method and coder according to the invention.

The method starts in process **271**. In process **272**, a frame is received from the demultiplexer **36** via the bus **45**. In process **273**, the scrambled payload field of the frame is

descrambled. This process may be omitted if the encoder did not scramble the payload (see above). In process 274, a test is performed on the master transition of the frame to determine whether the master transition is in the first state. The first state is 01 in the preferred embodiment. When the test result is YES, which indicates that the payload field of the frame is composed exclusively of information words, execution advances to process 277, which will be described below. When the test result is NO, execution advances to process 275.

A NO result in process 274 indicates that the payload field of the frame is not composed exclusively of information words, and therefore includes a TYPE word. In process 275, the TYPE word is extracted from the payload field.

In process 286, the payload field of the frame is expanded using the information provided by the TYPE word regarding the structure of the payload field. Expanding the payload field reverses the condensing that was applied by the encoder to the block from which the frame was generated. Thus, when the payload field is expanded, the coded control words are re-coded to yield eight-bit control words. Additionally, when the start of the packet or the end of the packet appears in the payload field, a start-of-packet control word or an end-of-packet control word, respectively, is inserted into the payload field. As noted above, the TYPE word indicates what portion of the payload field is occupied by coded control words, and the location in the payload field of the start of the packet or the end of packet. The processing performed in process 276 will be described in more detail below with reference to FIG. 9B. Execution then advances to process 277.

In process 277 the payload field is adopted as a block of received data.

In process 278, a test is performed to determine whether all frames have been processed. When the test result is YES, execution advances to process 279, where it ends. When the test result is NO, execution returns to process 272 via process 280 so that the next frame can be processed.

Process 276 of the method described above with reference to FIG. 9A will now be described with reference to FIG. 9B.

Execution starts In process 291.

In process 293, a test is performed to determine whether the TYPE word indicates that any coded control words appear in the payload field, i.e., whether the encoder 100 derived the payload field from a Type 2 block or a Type 4 through Type 11 block. When the test result is NO, execution advances to process 296, which will be described below. When the test result is YES, execution advances to process 294.

In process 294, the TYPE word is used to identify the portion of the payload field occupied by one or more coded control words, and the number of coded control words. It can be seen from FIGS. 7A-7L that the coded control words in the frame derived from each block Type differ in number but are always contiguous. However, in some frames, the coded control words abut the head of the payload field, whereas in others, the coded control words abut the end of the payload field.

In process 295, the coded control words identified by process 294 are decoded to yield the original control words.

In process 296, a test is performed to determine whether the TYPE word indicates that a packet starts or ends in the payload field, i.e., whether the encoder 100 derived the payload field from a Type 3 through Type 12 block. When the test result is NO, this indicates that the payload field was derived from a Type 2 block. In this case, execution

advances to process 299, which will be described below. When the test result is YES, execution advances to process 297.

In process 297, the position of the start of the packet or the end of the packet in the payload field is identified from the TYPE word.

In process 298, an SOP control word S or an EOP control word T is inserted into the payload field. The control word inserted, i.e., whether the control word S or T is inserted, and the position in the payload field at which the SOP or EOP control word is inserted are defined by the TYPE word. Execution then advances to process 299.

In process 299, execution returns to the main routine.

Either or both of the control word decoding performed in process 295 and the control word insertion performed in process 298 insert 8-bit control words into the payload field. This fills the space in the payload field formerly occupied by the TYPE word and, in some frames, fill bits.

FIG. 10A is a block diagram showing a first embodiment of the decoder 120. The decoder is composed of the frame decoder 191, the 64-bit parallel descrambler 192, the type word extractor 193, the block generator 194 and the block sequence detector 195.

The frame decoder 191 receives each 66-bit frame from the demultiplexer 36 via the 66-bit bus 45 (FIG. 1). The frame decoder reads the master transition at the front of the frame and feeds the master transition MT to the type word extractor 193. The frame decoder feeds the remaining 64 bits constituting the payload field of the frame to the descrambler 321.

The descrambler 192 is a self-synchronous polynomial descrambler that uses the same polynomial as was used by the scrambler 307 (FIG. 8) in the encoder to scramble the payload field. The descrambler is preferably a parallel descrambler to reduce latency. The descrambler descrambles the scrambled payload field received from the frame decoder 191 and feeds the resulting payload field PF to the type word extractor 193 and the block generator 194. In a decoder specifically designed for decoding frames in which the payload field has not been scrambled, the descrambler can be omitted.

The type word extractor 193 receives the payload field PF from the descrambler 192 and additionally receives the master transition MT from the frame decoder 191. The type word extractor operates only when the master transition is in its second state, corresponding to a frame whose payload field is not composed exclusively of information words. The type word extractor extracts the TYPE word from the sub-field 157 of the payload field 152 (FIG. 4C) and feeds the TYPE word to the block generator 194 and the block sequence detector 195.

The block generator 194 receives the payload field PF from the descrambler 192, the TYPE word from the type word extractor 193 and the master transition MT from the frame decoder 191. The block generator operates in response to the master transition. When the master transition is in the first state, the block generator adopts the payload field PF as a block of received data. When the master transition is in the second state, the block generator expands the payload field using the information provided by the type word regarding the structure of the payload field. Expanding the payload field reverses the condensing that was applied by the encoder to the block from which the frame was generated. Thus, when the payload field is expanded, the coded control words are re-coded to yield eight-bit control words. Additionally, when the start of the packet or the end of the packet appears in the payload field, a start-of-packet control word

or an end-of-packet control word, respectively, is inserted into the payload field. As noted above, the TYPE word indicates what portion of the payload field is occupied by coded control words, and the location in the payload field of the start of the packet or the end of packet. Finally, the block generator adopts the payload field after expansion as the block of received data.

The block generator 194 feeds the block of received data to the 4x8b/10b decoder 120 via the bus 43 (FIG. 1).

The decoder also includes the block sequence detector 195. The block sequence detector receives the TYPE word from the type word extractor 193 and the master transition MT from the frame decoder 191. The master transition of a frame and the TYPE word of the frame, when present, collectively define what kind of frame the frame is. As noted above, the frame can be one of four different kinds, namely, one composed exclusively information words D (generated from Type 1 block), one that includes the start of a packet S (generated from Type 3 or Type 4 block), one that includes the end of a packet T (generated from one of Type 5 through Type 12 block) and one composed exclusively control words Z (generated from Type 2 block). The encoder generates the four different kinds of frames in a predetermined order, namely: S, D, . . . , D, T, Z, . . . , Z, S, D, . . . , D, T, Z, . . . , Z, etc. The frames must be received by the decoder 120 in the same predetermined order. The block sequence detector monitors the order of the kinds of frame received, and generates the error flag ERR when the TYPE word and the master transition indicate that the frame is of a kind that violates the predetermined order. The block generator 194 adds the error control word E to the block of received data generated from the frame in response to the error signal. The error control word causes the MAC 12 (FIG. 1) to void the packet of which the block forms part.

FIG. 10B is a block diagram showing a second embodiment of the decoder 120. The decoder is composed of the frame decoder 320, the 64-bit parallel descrambler 321, the payload field decoder 322 the type word decoder 323, the STZ decoder 324 and the multiplexer 325.

The frame decoder 320 is connected by the 66-bit wide bus 45 to the output of the demultiplexer 36 (FIG. 1) from which it receives each frame recovered from the received bitstream. The frame decoder reads the master transition at the front of the frame and feeds the master transition MT to the type word decoder 323 via the 2-bit bus 330. The frame decoder feeds the remaining 64 bits constituting the scrambled payload field of the frame to the descrambler 321 via the 64-bit bus 331.

The descrambler 321 is a self-synchronous polynomial descrambler that uses the same polynomial as was used by the scrambler 307 (FIG. 8) in the encoder to scramble the payload field. The descrambler is preferably a parallel descrambler to reduce latency. The descrambler descrambles the scrambled payload field received from the frame decoder 320 and feeds the resulting payload field to the payload field decoder via the 64-bit bus 332. Additionally, the eight bits closest to the head of the payload field output by the descrambler, i.e., the bits that represent the TYPE word when the TYPE word is present in the payload field 152 (FIG. 4A), are fed additionally to the type word decoder 323 via the eight-bit bus 333.

The type word decoder 323 receives the master transition MT from the frame decoder 320 and additionally receives eight-bit words, some of which are TYPE words, from the descrambler 321. When the master transition is 10, indicating that the payload field is not composed exclusively of information words, the 8-bit word received via the bus 333

is the TYPE word extracted from the payload field. The type word decoder truncates the TYPE word to its first four bits and feeds the truncated TYPE word to the payload field decoder 322 via the four-bit bus 334. Alternatively, the TYPE word may be used without truncation.

When the master transition is 01, indicating that the payload field is composed exclusively of information words, the type word decoder performs no decoding of the 8-bit word received via the bus 333. Instead, the type word decoder generates an additional truncated TYPE word that indicates that the payload field is composed exclusively of information words. It should be noted that, even with the additional truncated TYPE word indicating a payload field composed exclusively of information words, the set of TYPE words is sufficiently small for the TYPE words to be reliably represented by a four-bit code in the internal processing performed by the decoder.

The type word decoder 323 additionally includes a block sequence detector (not shown) similar to the block sequence detector 195 described above. The block sequence detector uses the master transition MT and the TYPE words to track the order of the kinds of frame and sends an error signal ERR to the STZ decoder 324 via the connection 336 when the order of the kinds of frame deviates from the predetermined order described above.

The payload field decoder 322 receives the payload field from the descrambler 321 and additionally receives the corresponding truncated TYPE word from the type word decoder 323. The payload field decoder examines the truncated TYPE word to determine the structure of the payload field, i.e., which data elements of the payload field are information words, which data elements are coded control words and the position of the start of a packet or the end of a packet (if any) in the payload field. In response to the structure defined by the truncated TYPE word, the payload field decoder transfers the contents of the payload field to an eight-word, 64-bit block. A set of 64, three-input data selectors that operate in response to the TYPE word can be used for this.

When the TYPE word corresponds to a Type 3 through 12 block, the payload field decoder 322 inserts into the block a start-of-packet control word S or an end-of-packet control word T in the position in the block indicated by the truncated TYPE word. The payload field decoder feeds the 64-bit block to the STZ decoder 324 via 64 of the 72 conductors of the bus 336. The payload field decoder additionally feeds, via the remaining eight conductors of the bus 336, a set of eight control word flags for the block. The control word flags indicate whether each word in the block is an information word or a control word. The payload field decoder selects the set of control word flags fed to the STZ decoder with each block in response to the truncated TYPE word, because the block Type of the block defines whether each word of the block is an information word or a control word.

The STZ decoder 324 operates in response to the eight control word flags received together with the block from the payload field decoder 322. The STZ decoder decodes the coding of each coded control word in the block to recover the original eight-bit control word. The words in the block subject to decoding are indicated by their respective control word flags indicating that the words are coded control words.

The STZ decoder 324 builds two quads by transferring the first four words of the block and their respective control word flags to the 36-bit bus 337, and by transferring the second four words of the block and their respective control

word flags to the 36-bit bus **338**. The busses **337** and **338** feed the quads and their control word flags in parallel to the multiplexer **325**.

The multiplexer **325** alternately feeds the quads and their respective control word flags received via the busses **337** and **338** to the 4×8b/10b encoder **38** via the pseudo-XGMII bus **43**.

The invention provides a coding method with a very low overhead when implemented as a 64b/66b code (3.125%). The overhead is substantially lower than 8b/10b (25%). The coding method according to the invention employs a single, self-synchronizing scrambler. Other coding schemes require periodic transmission of synchronization information and complex techniques to initialize non-self-synchronous scramblers. Embodiments of the and coding method according to the invention good error detection properties for 10 Gb/s Ethernet when the scrambler polynomial is specifically chosen not to interfere with the Ethernet-standard CRC-32 coding. Such embodiments provide an excellent mean time to false packet acceptance (MTFPA) by choosing the TYPE words and the control words to have a 4-bit minimum Hamming distance. At a bit error rate of 10^{-9} and a bit rate of 10.3 Gb/s, embodiments of the coder and coding method have an MTFPA approximately equal to that of 1 Gb/s Ethernet, which uses 8b/10b line code, at a bit error rate of 10^{-11} . Embodiments of the coding method according to the invention begin encoding as soon as enough information words are acquired—in particular, it is not required to buffer an entire Ethernet packet prior to transmission. Embodiments of the coding method according to the invention allow Ethernet data to be transmitted at a bit rate of 10.0 Gb/s using existing lasers designed for use in SONET OC-192 transmitters. Adoption of 10 Gb/s Ethernet standard based on the coding method according to the invention does not have to wait for lasers capable of modulation at 12.5 Gbaud to be developed.

Although this disclosure describes illustrative embodiments of the invention in detail, it is to be understood that the invention is not limited to the precise embodiments described, and that various modifications may be practiced within the scope of the invention defined by the appended claims.

We claim:

1. A data coding method, comprising:
 - receiving blocks of input data, the input data comprising packets of information words, the packets preceded and followed by control words;
 - appending a master transition to the beginning of each block to form a respective frame for transmission, the master transition having a sense that depends on whether the block contains any control words; and
 - for each block that contains one or more control words, additionally:
 - generating a TYPE word indicating a structural property of the block,
 - condensing the block to accommodate the TYPE word, and
 - inserting the TYPE word into the block.
2. The method of claim 1, in which the TYPE word indicates that the block contains no information words.
3. The method of claim 1, in which the condensing comprises re-coding the control words using the fewer bits.
4. The method of claim 1, additionally comprising recoverably scrambling the block prior to the appending.
5. The method of claim 4, in which:
 - the TYPE word is one of a set of T-bit TYPE words having a specified mutual Hamming distance; and

the scrambling comprises using a polynomial having coefficients separated by greater than T.

6. The method of claim 1, in which the TYPE word indicates the position in the block of the start of a packet.

7. The method of claim 6, in which the condensing comprises removing from the block a control word that indicates the start of the packet.

8. The method of claim 7, in which condensing the block additionally comprises re-coding remaining ones of the control words using the fewer bits.

9. The method of claim 8, in which, the re-coding comprises re-coding the control words using codes having a specified mutual Hamming distance.

10. The method of claim 1, in which the TYPE word indicates the position in the block of the end of a packet.

11. The method of claim 10, in which the condensing comprises removing from the block a control word that indicates the end of the packet.

12. The method of claim 11, in which the condensing additionally comprises re-coding remaining ones of the control words using the fewer bits.

13. The method of claim 12, in which the re-coding comprises re-coding the control words using codes have a specified mutual Hamming distance.

14. The method of claim 1, in which the TYPE word is one of a set of TYPE words having a specified mutual Hamming distance.

15. The method of claim 14, additionally comprising recoverably scrambling the block prior to the appending.

16. The method of claim 15, in which:

the TYPE words are T-bit words; and

the scrambling comprises scrambling the block using a polynomial having coefficients separated by greater than T such that a single error in transmitting the frame, when the scrambling is recovered, will not cause multiple errors to fall within any of the TYPE words and degrade the minimum Hamming distance of the TYPE words.

17. The method of claim 14, in which:

the TYPE words are each T-bit words; and

the method additionally comprises generating the set of possible TYPE words by a process comprising:

adopting a (T/2)-bit binary pattern as a first half of a possible TYPE word, and

generating a second half of the possible TYPE word by duplicating or complementing the first half of the possible TYPE word depending on a bit parity value of the first half of the possible TYPE word.

18. The method of claim 17, additionally comprising adopting ones of the possible TYPE words having the specified mutual Hamming distance as the set of TYPE words.

19. The method of claim 17, in which the generating comprises duplicating the first half of the possible TYPE word when the bit parity is even.

20. The method of claim 17, in which the generating comprises complementing the first half of the possible TYPE word when the bit parity is odd.

21. A data coding method, comprising:

receiving 64-bit blocks of input data, the input data comprising packets of information words, the packets preceded and followed by control words;

appending a 2-bit master transition to the beginning of each block to form a respective 66-bit frame for transmission, the master transition having a sense that depends on whether the block contains any control words; and

25

for each block that contains one or more control words, additionally:
generating an 8-bit TYPE word indicating a structural property of the block,
condensing the block to 56 bits to accommodate the TYPE word, and
inserting the TYPE word into the block.

26

22. The data coding method of claim 21, in which the structural properties indicated by the TYPE word comprise the position of the start of the packet in the block, the position of the end of the packet in the block, and the block being composed exclusively of control words.

* * * * *