

Consciousness, Communication and Cooperation

in brains, bodies, businesses, and biospheres

A chalk talk presented at Agilent Labs, Palo Alto

June 29, 2001

Rick Walker

*We can't solve problems by using the same kind of
thinking we used when we created them.*

-Albert Einstein

Outline

- What is taught by “the wisdom traditions?”
- What is consciousness/computation?
- How does our brain work? (two modes)
- A formal analogy: Quantum Computation
- Applications: Brain, Body, Business, Biospheres
- Is this really feasible? past - present - future

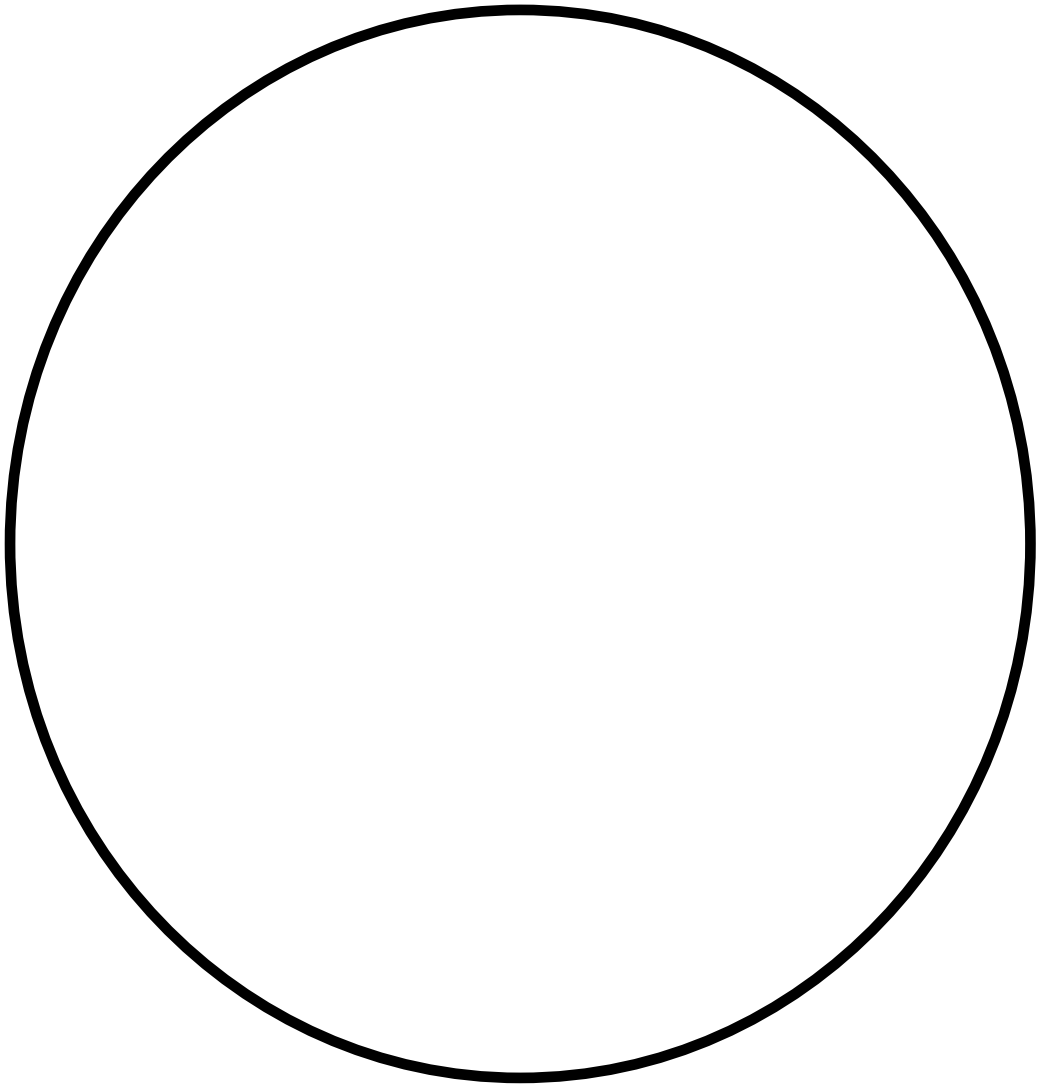

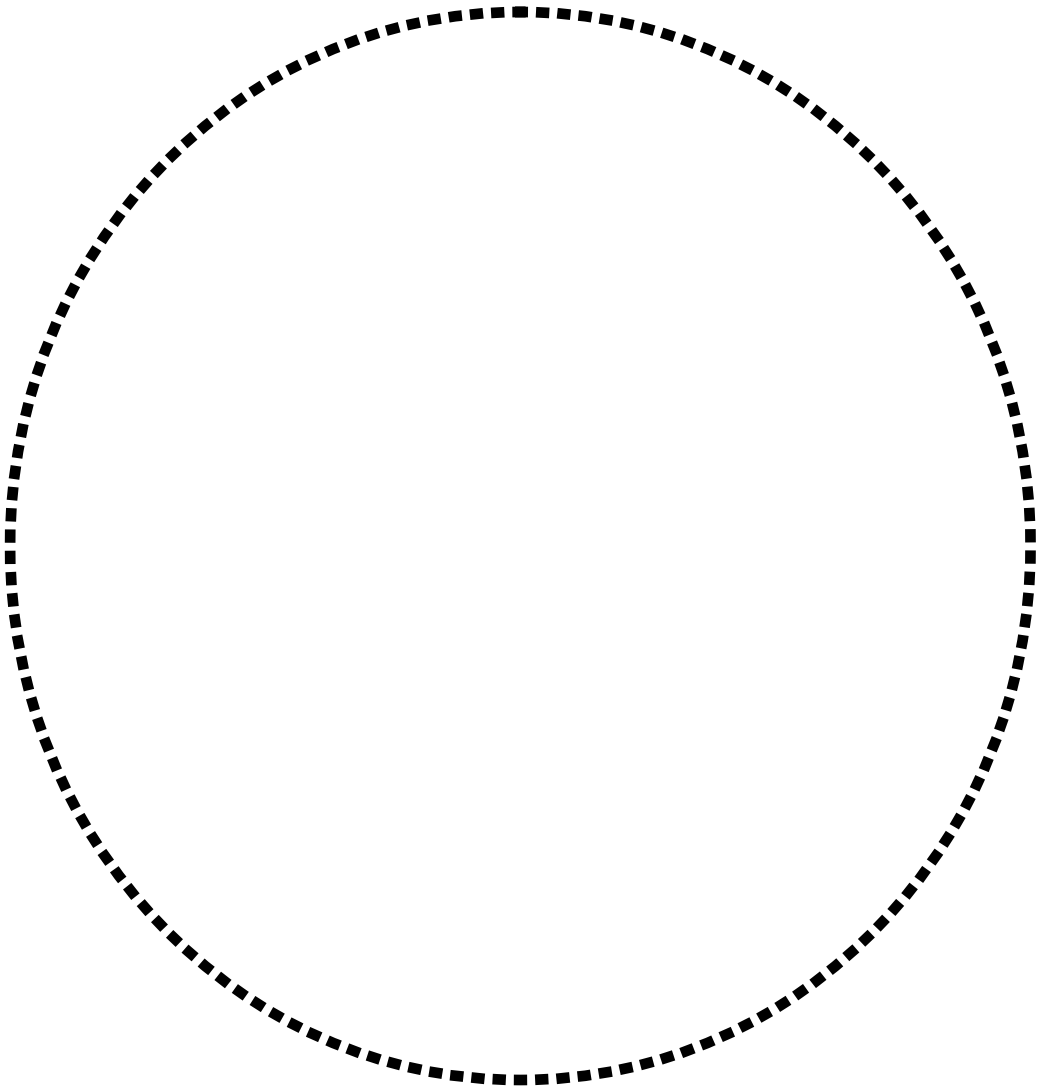

Kohlberg's 6 levels of Moral development

from: <http://www.nd.edu/~rbarger/kohlberg.html>

Level	Stage	Social Orientation
Pre-Conventional	1	Obedience and Punishment
	2	Individualism, Instrumentalism and Exchange
Conventional	3	"Good boy/girl"
	4	Law and Order
Post-Conventional	5	Social Contract
	6	Principled Conscience

Philip Crosby's 5 levels of Maturity

Level	Name	Management Style	Individual Approach	Critical Domain
1	Suppressed	Fear	Displacement	None, product
2	Enabled	Ignoring	Skunkworks	Near
3	Encouraged	Supporting	Analytic/Intuition	Process
4	Educated	Training	Tools, skill	Distant
5	Enlightened	Deep Understanding	Appropriate	Strategic

See Philip Crosby, "Quality is Free", Mentor Books, New York, 1979 - quoted in Paul Straker "Quo Vadis Nunc: where does an innovative company go next?", Hewlett-Packard internal Memo, June 1998.

Evolution of Mathematical Concepts

pure ego "just me"	I,II,III $- = \equiv$	integers
admit existence of "not me"	0	zero , place value
interactions of multiple egos	$\text{III} - \text{II} = \text{I}$ $5/2 = \begin{array}{c} \bullet \bullet \bullet \\ \bullet \bullet \end{array} = 2 \frac{1}{2}$	rational numbers: multiplication, division addition, subtraction
meta inquiry about math	$A \times A = B, A = \text{sqrt}(B)$	irrational numbers
self referential paradox	$A^2 = -1$ $A = -1/A$	imaginary numbers complex analysis waves, fields
properties of non-pointlike shapes	$C = 2\pi r$	transcendental numbers

Nature of Cognition - linear spaces

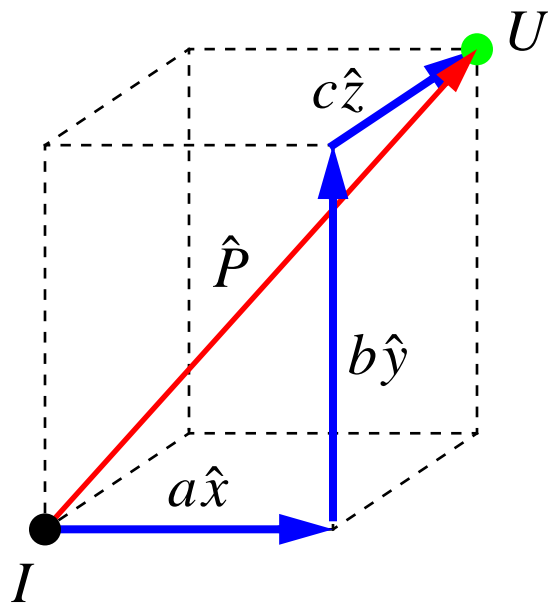

Descartes described point U w.r.t. an origin I by a vector

$$\hat{P} = \overrightarrow{IU} = a\hat{x} + b\hat{y} + c\hat{z}, \text{ where}$$

$$a = \hat{P} \bullet \hat{x}$$

$$b = \hat{P} \bullet \hat{y}, \text{ with } A \bullet B \equiv \sum_{k=1}^n A_k B_k.$$

$$c = \hat{P} \bullet \hat{z}$$

This is fundamental. For “I” to see “U”, a projection onto arbitrary “archetypic” basis vectors must be made. This mechanism works by analogy in *any* n-dimensional space - including general Human cognition.

Time and Frequency Domains

To describe an object in “reality”, you need to define a set of orthogonal basis functions, which you’ll use, in linear combinations to represent the object. Projections of the object onto each basis function (analogous to a dot product) determines the weighting coefficient of each basis function.

The mathematical equivalent of a dot product for functions (rather than vectors) is the inner product:

$$(f, g) = \int_a^b f(x)g(x)dx$$

Time Domain

When we think about a function of time “ $f(t)$ ”, we implicitly are using $\delta(t)$ as the basis function.

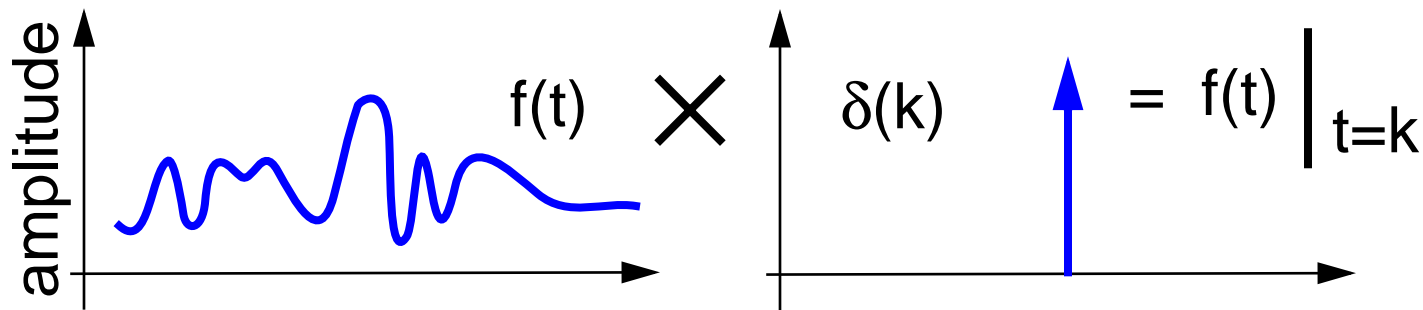

The underlying philosophy is time as a *linear history*, in which the value of each moment is what is interesting (a finite game*).

Good news/bad news: This projection gives the *exact value* is at instant, but says *nothing* about trends, cycles or changes...

* see James P. Carse, “Finite and Infinite Games”, Ballantine Books 1994

Frequency Domain

When we think about a spectrum “H(f)”, sin() and cos() are the basis functions.

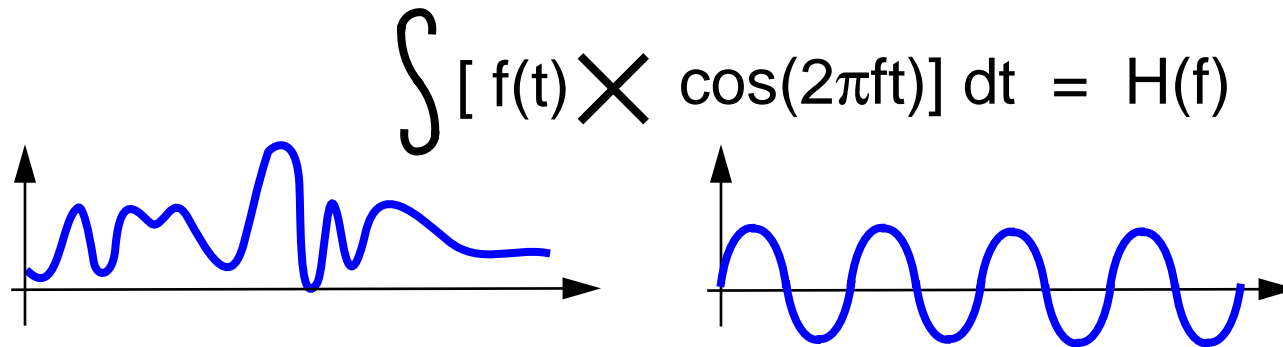

This philosophy here is time as a *cyclical process*, in which the sequence of events and their relations to each other is what matters (an infinite game*).

Good news/bad news: This projection gives the *exact* amplitude of a cycle at any given periodicity, but says *nothing* about the instantaneous value of the signal...

* see James P. Carse, “Finite and Infinite Games”, Ballantine Books 1994 for a brilliant discussion of these two modes of approaching the world.

The Universe is Fractal...

... meaning that the same mathematical paradigms recur at all size and time scales. Consider the following self-similar sequence:

$$s(0) = \{ 0 \ 1 \}$$

$$s(1) = \{ 0 \ 1 \ 1 \ 0 \}$$

$$s(2) = \{ 0 \ 1 \ 1 \ 0 \ 1 \ 0 \ 0 \ 1 \}$$

$$s(3) = \{ 0 \ 1 \ 1 \ 0 \ 1 \ 0 \ 0 \ 1 \ 1 \ 0 \ 0 \ 1 \ 0 \ 1 \ 1 \ 0 \}$$

The spectrum $H(f)$ of $s(n)$ is $1/f$ - increasing *without limit* as f goes to zero.

Other $1/f$ processes include: voltages, currents or resistances in electronic devices, average seasonal temperature and rainfall, internet traffic volume, economic data, and both the loudness and pitch of music.

Fractals imply Metaphor



If you understand something about a mathematical dynamic - and can map it properly onto different problem domains - then you have wisdom.

Let's develop several metaphors that will shed some light on:

- how the brain operates
- how businesses are organized
- how planetary ecology operates

In a deep sense, these all follow the same dynamics...

What is Computation?

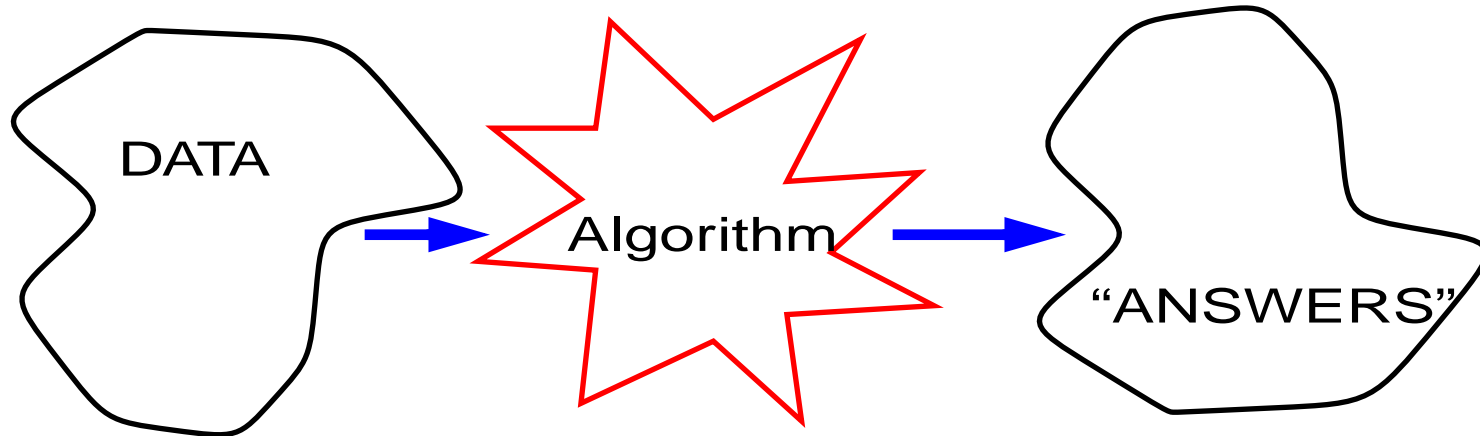

All Computation is merely a re-presenting of the data in a new set of basis vectors. (Remember GIGO?) Eg: factoring algorithms simply take numbers represented as an integer and transform them into a list of factors. Both representations are equivalent pieces of information.

What is implicit in one representation may be explicit in another and vice-versa.

What is Consciousness?

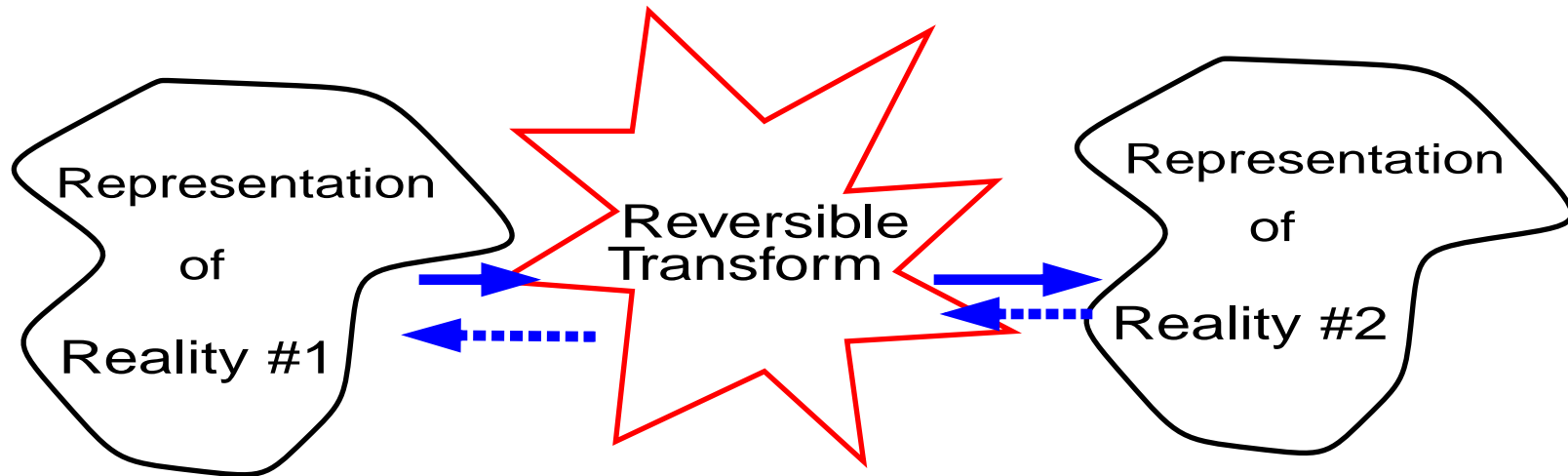

Self-Awareness involves at least two representational modes (a duality) interacting in such a way that they represent the identical information simply cognized and re-cognized in two different basis systems. Information implicit in one domain is explicit in the other and vice-versa. The two systems maintain coherence by updating information via the Unitary transform which links the two domains.

at least two ways of “thinking”

left-brain	right-brain
“rational”	“intuitive”
ego based	non-egoic
particles	waves
the one, standing separately	the many, taken as a unity
classical	quantum
linear time	cyclical time
Logos	Eros

Claim: These two modes arise from deep structures in consciousness. These two principles arise at many levels of scale, often in conflict, and are inseparable, intrinsic components of consciousness.

Carver Mead's assertion

Boolean, symbolic, Von-Neuman-like algorithms are incapable of playing grand-master level chess on human wet-ware.

- Although computers now play chess at grand-master level, (at 200 million moves/sec), no programs exist to play "Go" at better than an intermediate level.
- How does the brain work?
- How can we encourage more of this?
- Does the result apply to larger computational aggregates such as companies and nations?

holographic storage

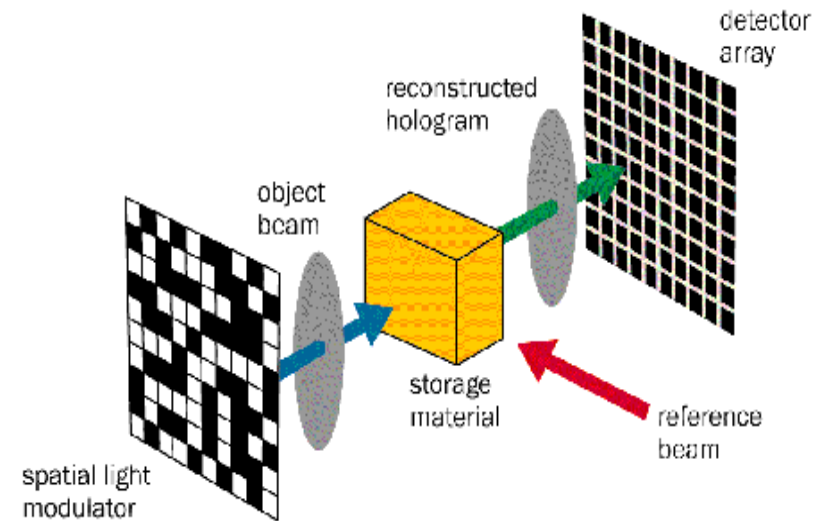
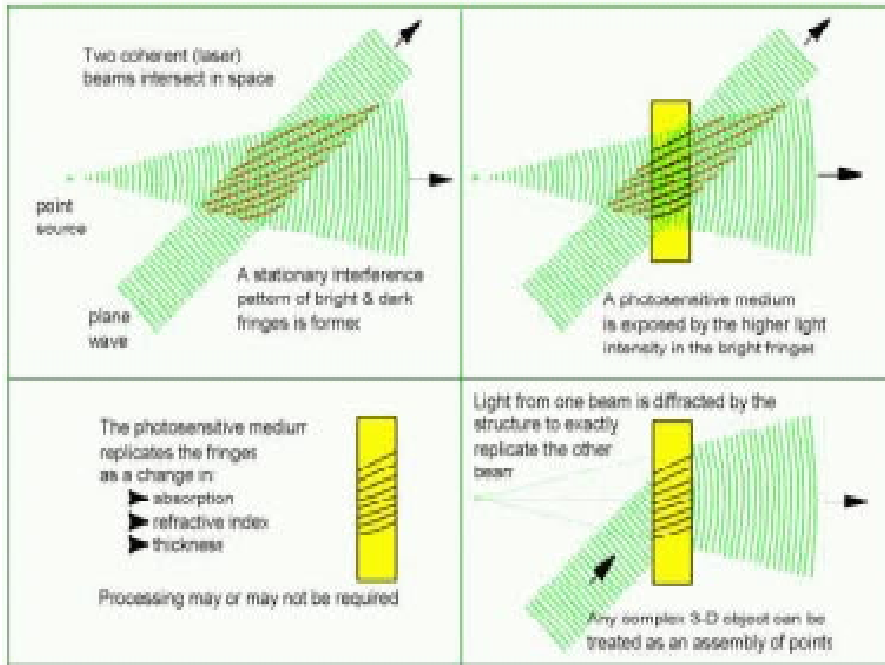

<http://www.almaden.ibm.com/st/projects/holography/>

<http://www.nottingham.ac.uk/~ppyrcc/Applications.htm>

A Holonic Model of Consciousness

- Deutsch's conjecture: Replicators replicate more efficiently if they can internally simulate the possible results of their actions. Organisms possessing an internal "virtual reality simulator" of possible actions will out-compete organisms that do not. Life is therefore synonymous with possession of such a "mind".

The human brain likely operates on principles mathematically homologous to the physics of the outside world. This maximizes the chances that "thinking" about the world is accurate.

Since we inherit our neural structures from creatures with nano-scale interactions, I suggest that our brain operates in a way that simulates quantum interactions, and also possesses the intrinsic behavior of Maxwell's equations.

Neuron operation

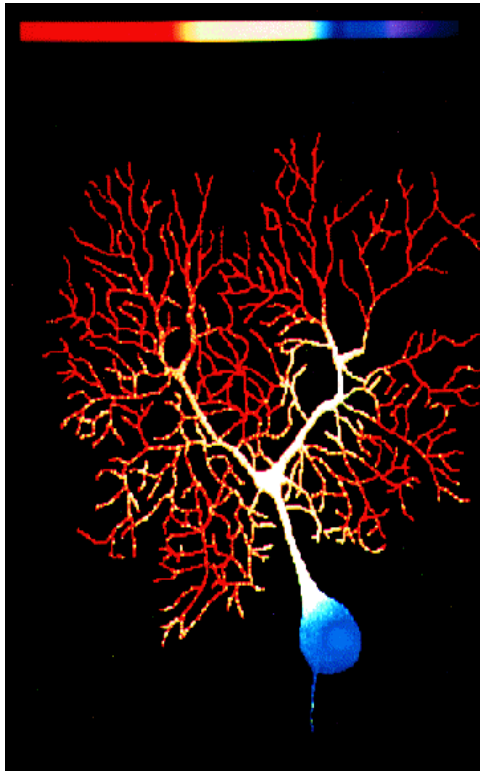

- Each neuron interconnects with hundreds of other neurons through synapses
- Synapses can be inhibitive or excitative
- Stimulation from adjacent synapses is multiplicative rather than additive
- Timing is critical. Over large areas, the triggering time is coherently controlled to about 1/1000 sec.
- Both forward and backward propagation occurs in synapses

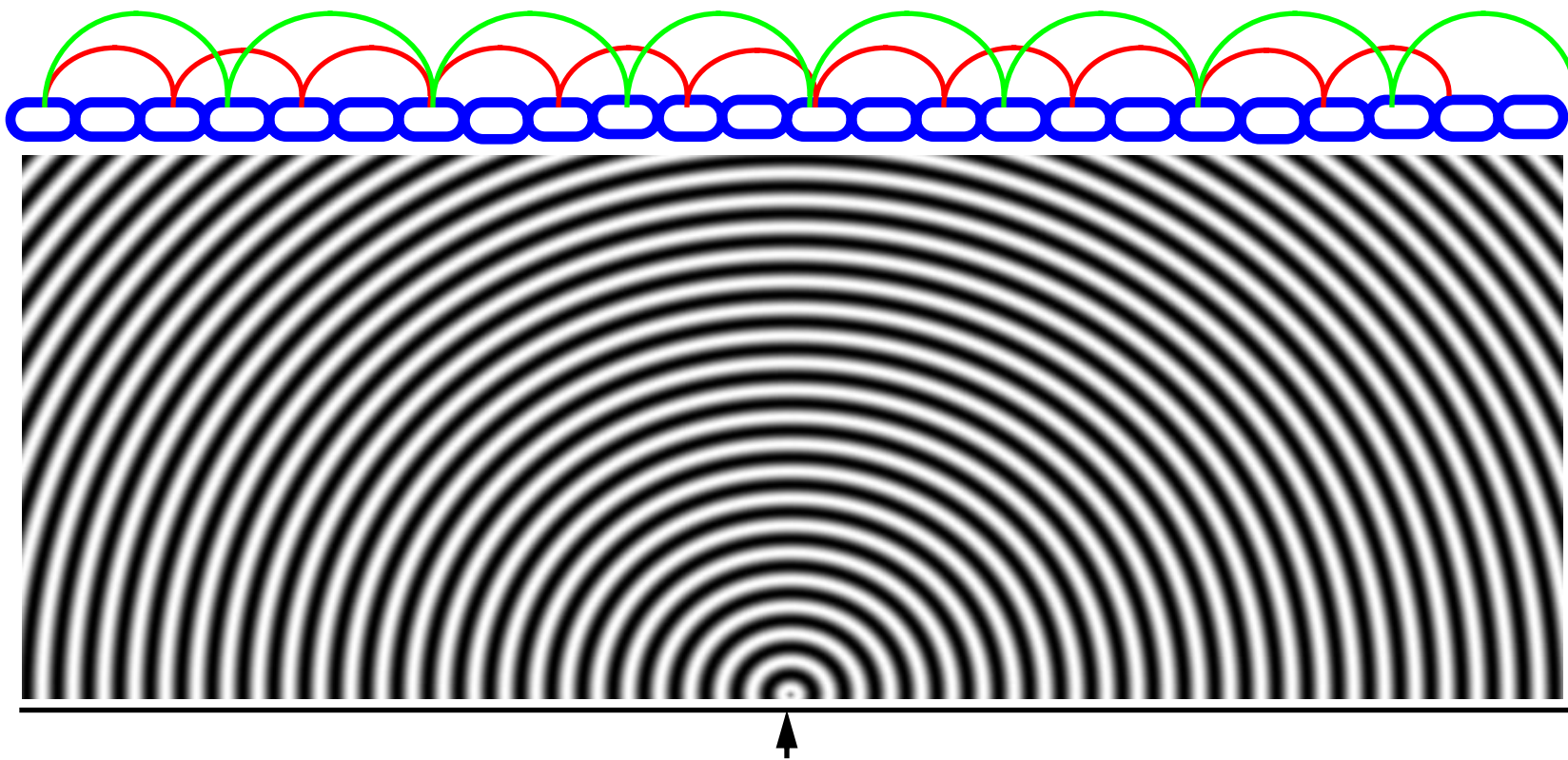

Sensory Input eg: from Retina (one bright spot)

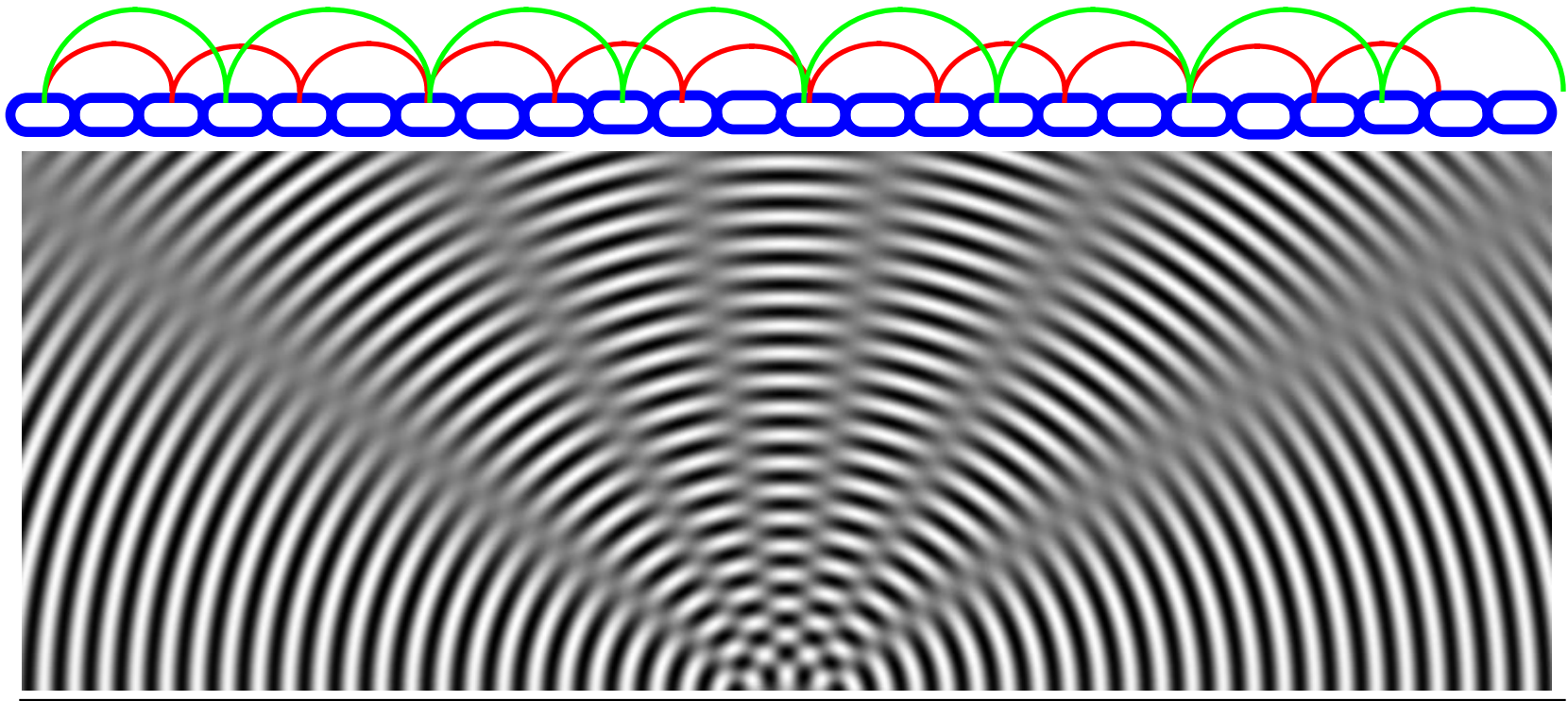

Sensory Input eg: from Retina (two closely-spaced bright spots)

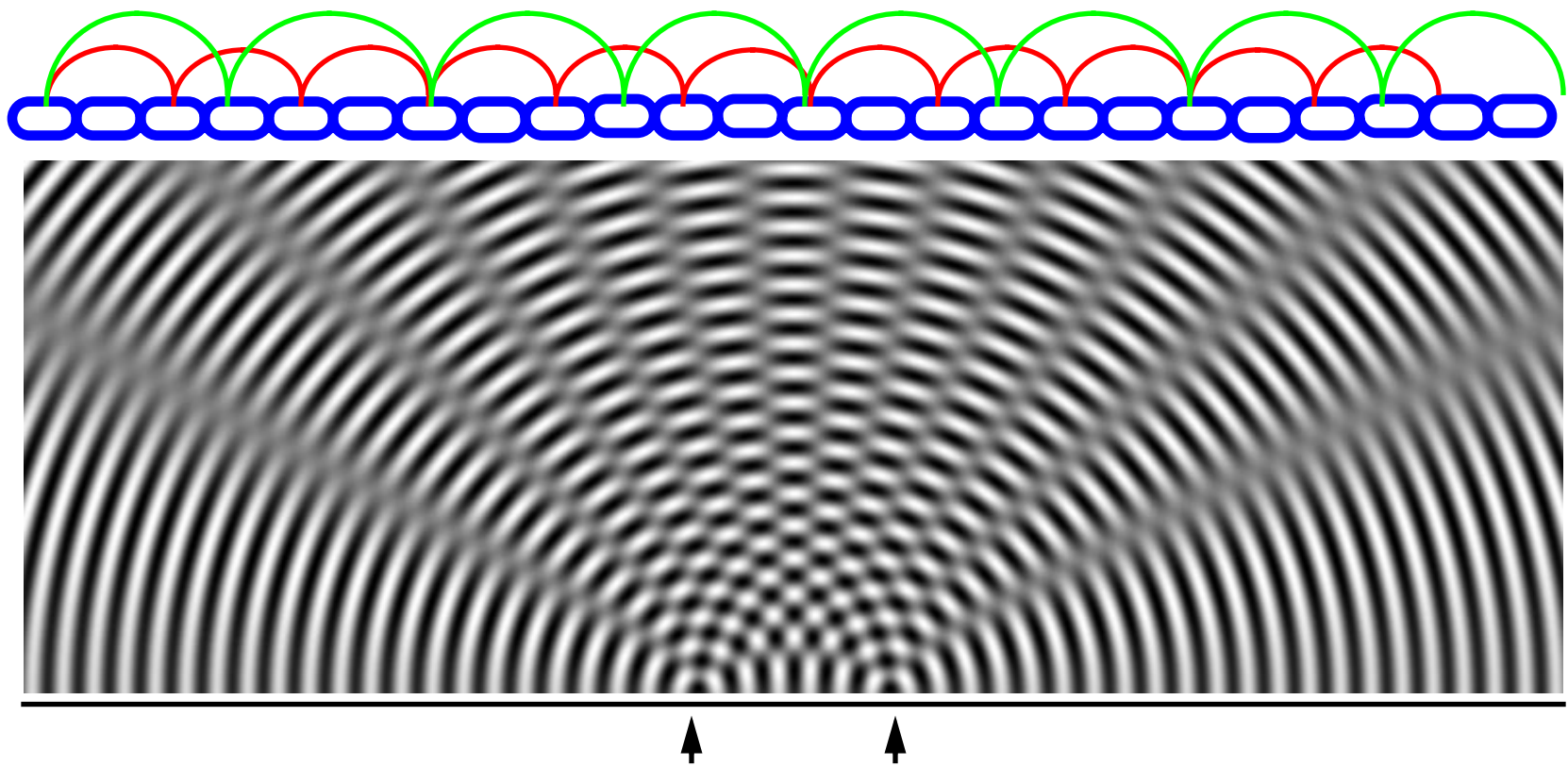

Sensory Input eg: from Retina (two more-widely-spaced bright spots)

Senses, holograms and thought

- “Here we directly investigated the neuronal substrates of visual recall by recording from single neurons in the human medial temporal lobe while the subjects were asked to imagine previously viewed images. [...] Of the neurons that fired selectively during both vision and imagery, the majority (88%) had identical selectivity”.

See Gabriel Kreiman, Christof Koch and Itzhak Fried. Imagery neurons in the human brain *Nature* (2000) 408, 357-361

- The same structures that are used to recognize features in the world appear to be the same structures that are used to abstractly think about world.
- The mind can only see what it is prepared to see. - Edward de Bono

↑ to other neural centers via spine

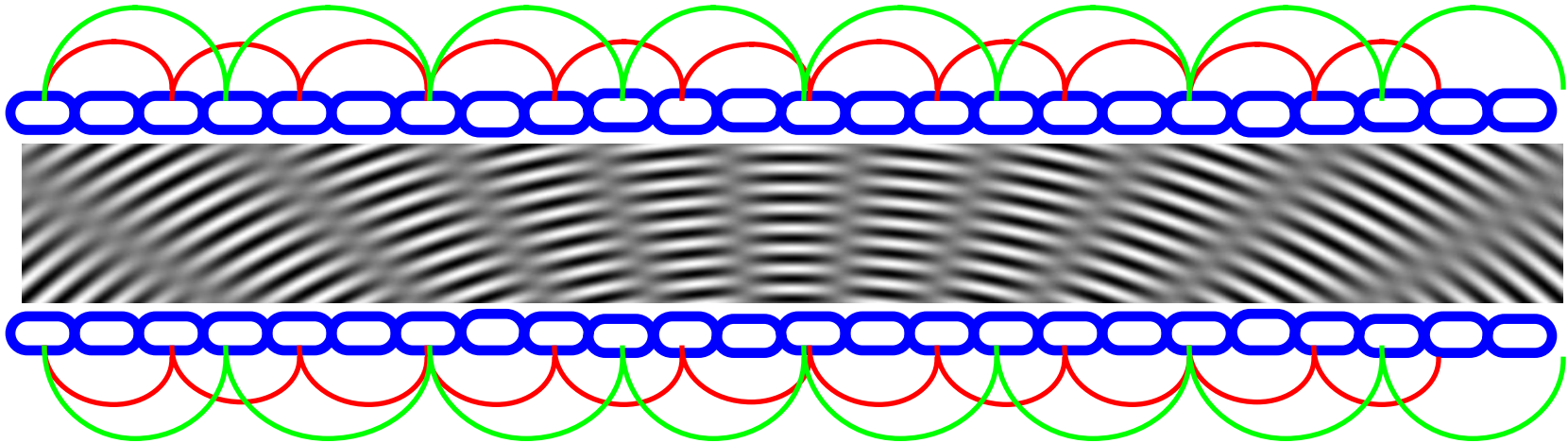

Sensory Input

Wave or Particle?

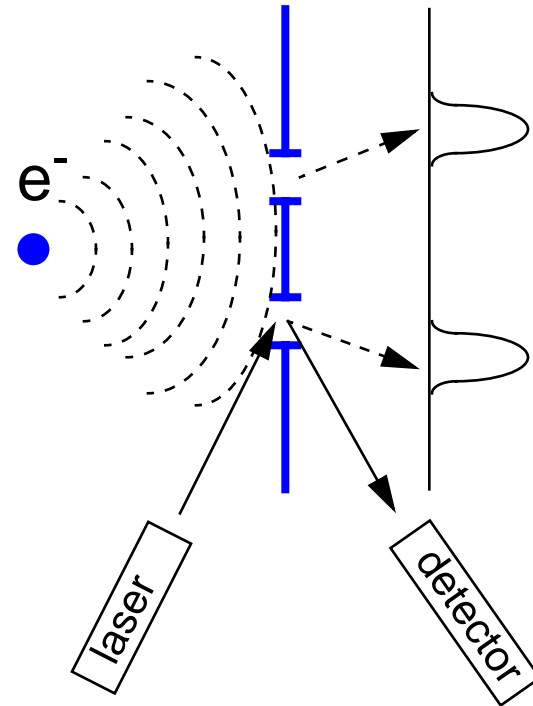
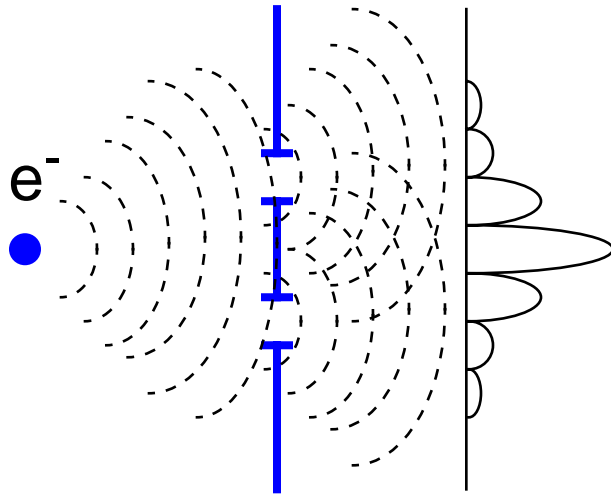

Insisting on “knowing” the intermediate state (making a symbol) destroys the correlated “omniscient” interference effects.

Pretty pictures

input image

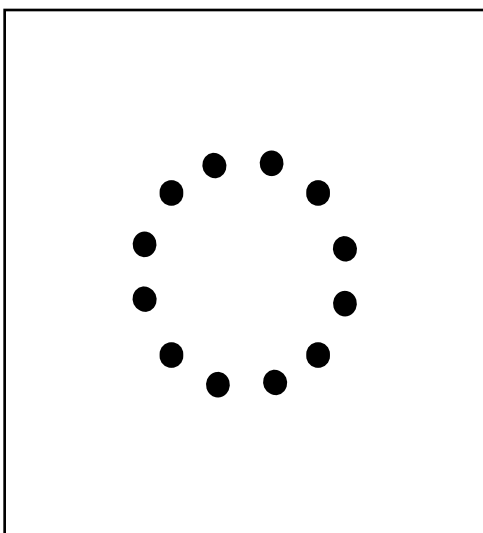
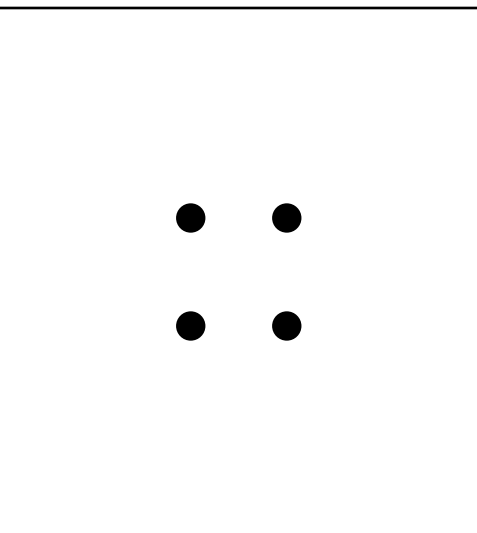
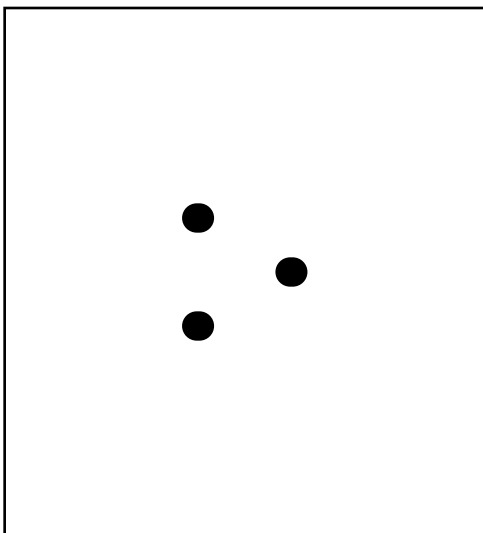

interference hologram

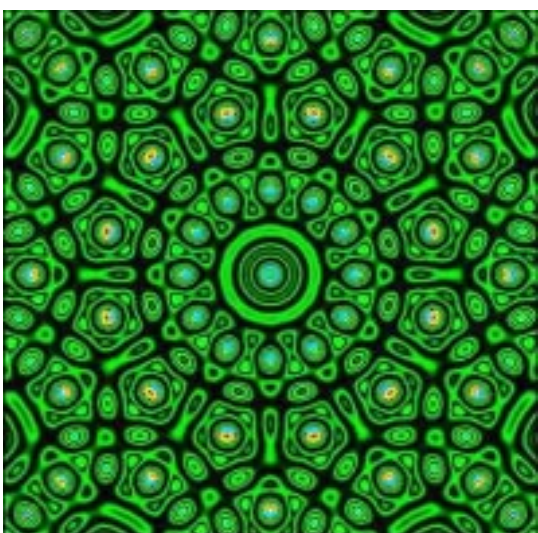
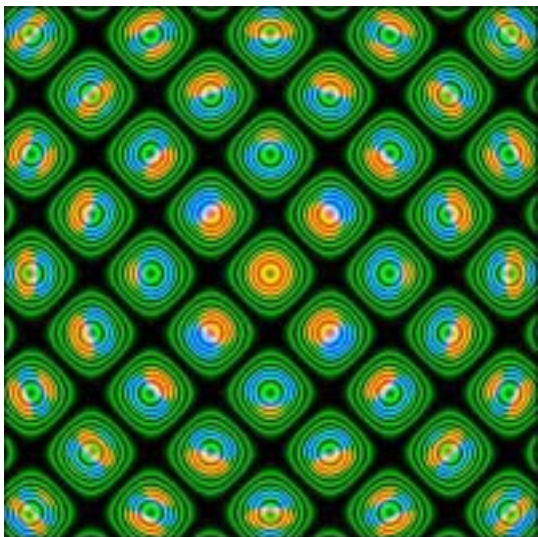
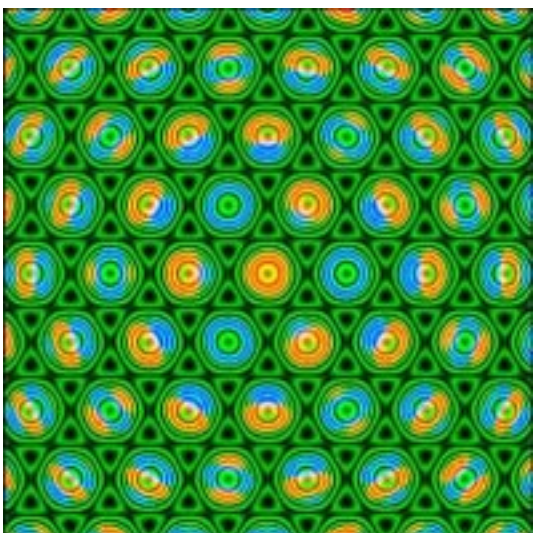

Some features of theory

- Images with bilateral symmetry focus energy into central saggital plane of visual cortex - the fundamental physics of the brain provides a method for recognizing most higher forms of life.
- Images with circular symmetry (fresnel rings) focus energy into a compact region of the visual cortex - the fundamental physics provides strong pattern match to the mother's breast.
- Propagated interference patterns at the fourier plane are magnitude invariant to shifts in the image plane - once you recognize a feature, you still will recognize it with translation.

Conceptual view of Holographic Display

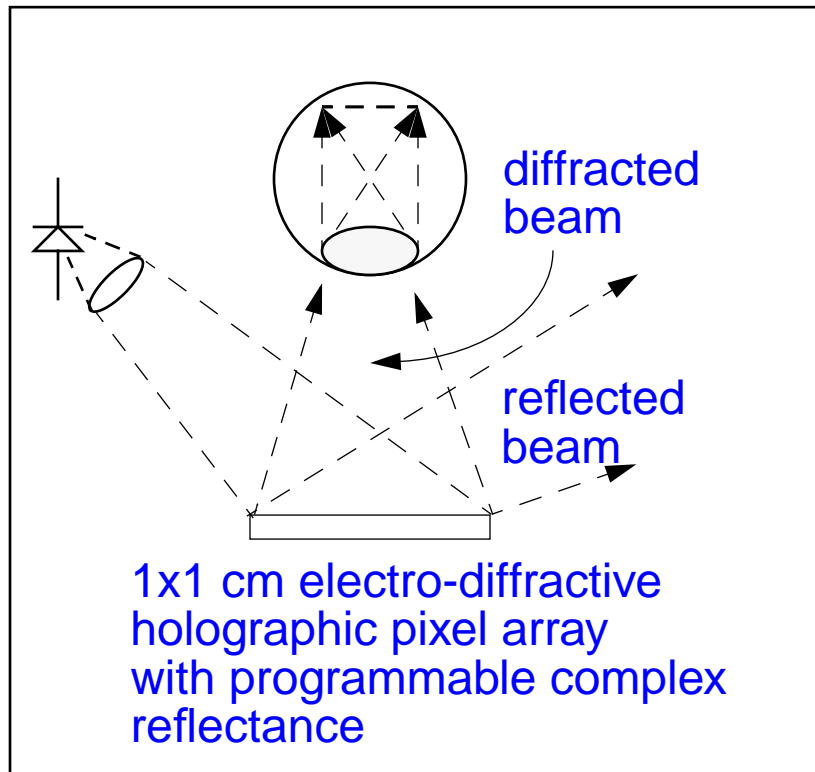

- no viewing optics required
- ultimate in light weight
- eye perceives display as a “clear window” onto a computed scene
- phase of “virtual-pixel” is a free variable to simplify hologram calculation

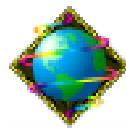

Holographic Display Concept

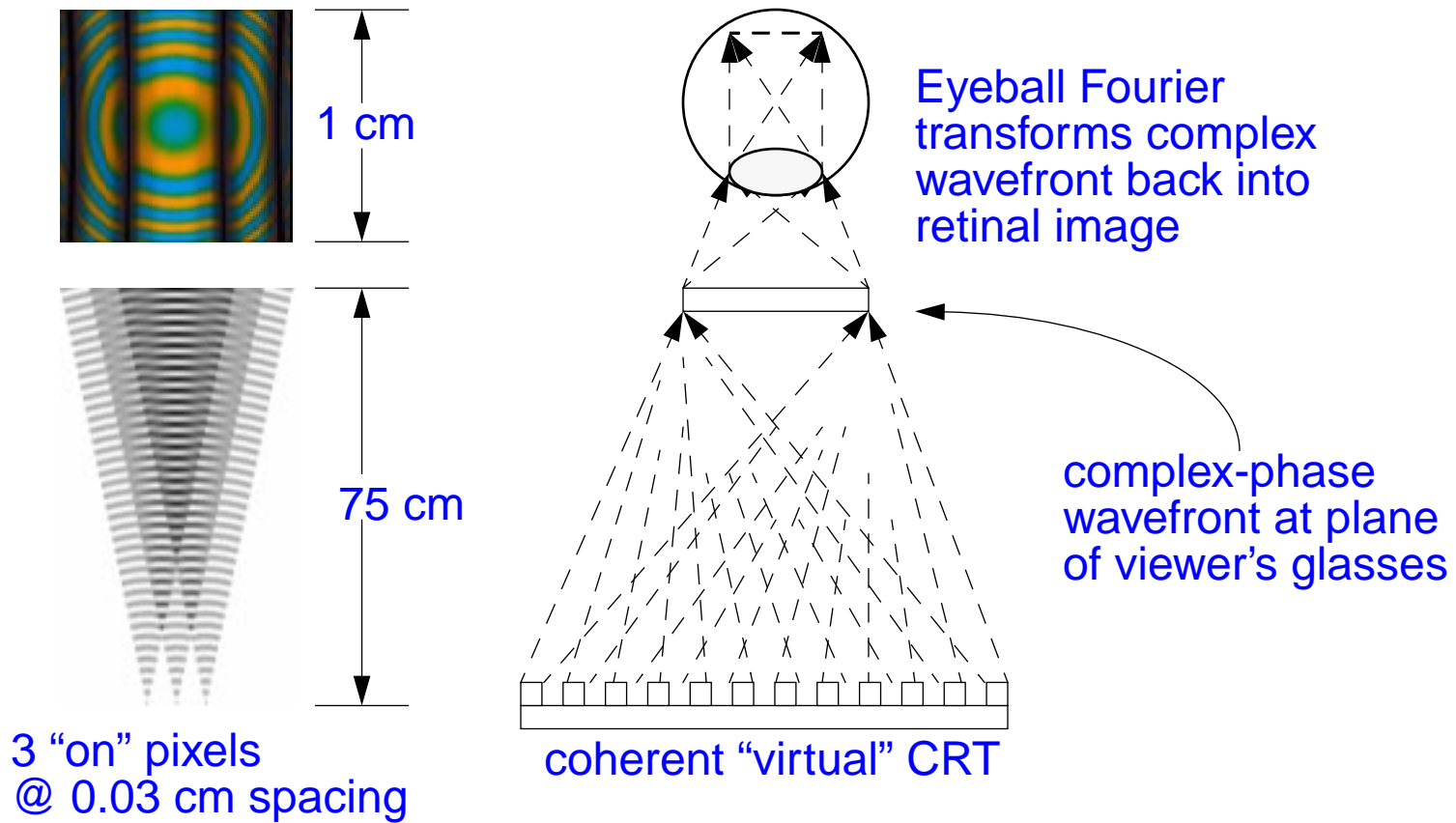

Computing a phase-only Hologram

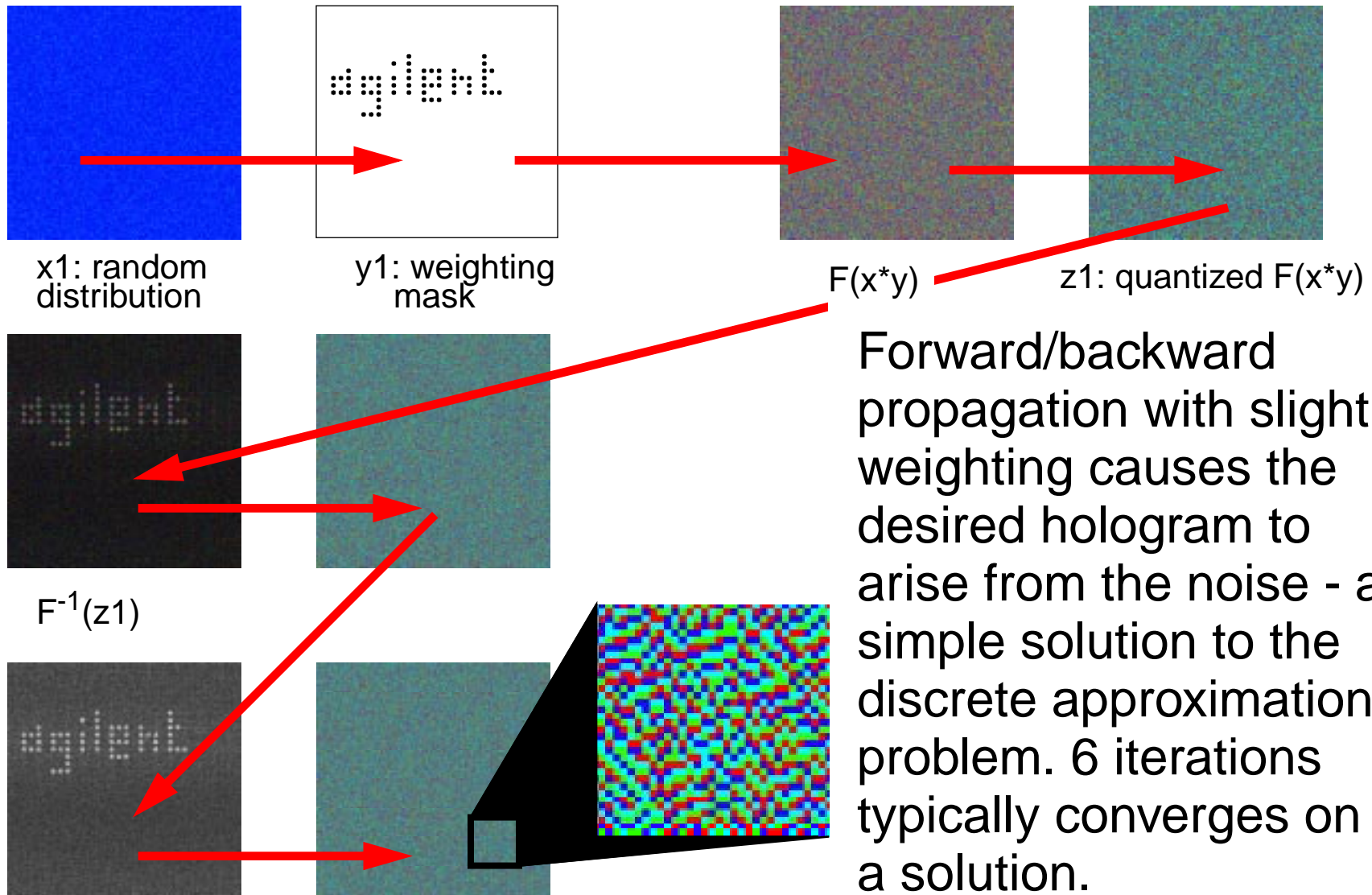

Libet's experiment

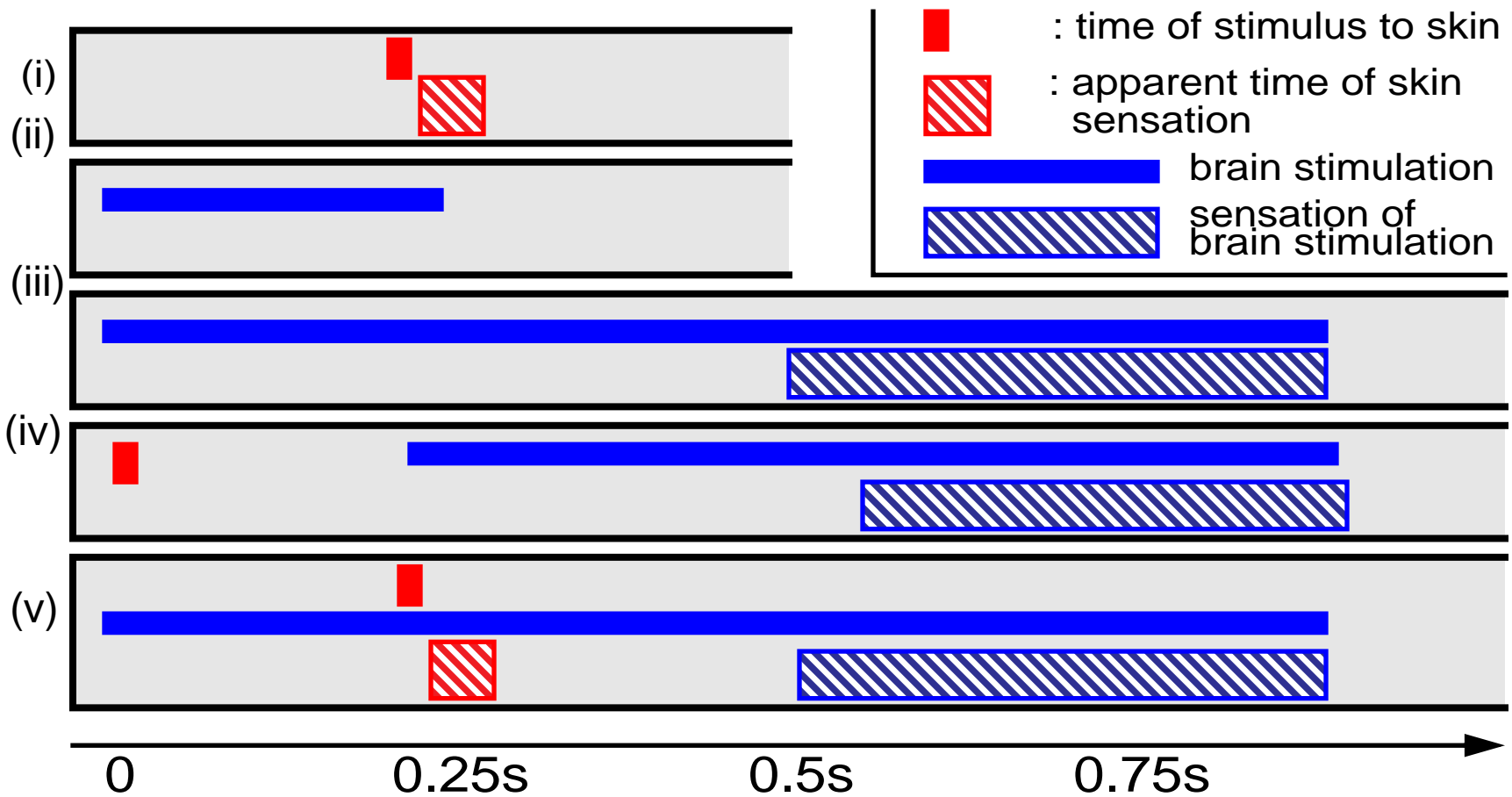
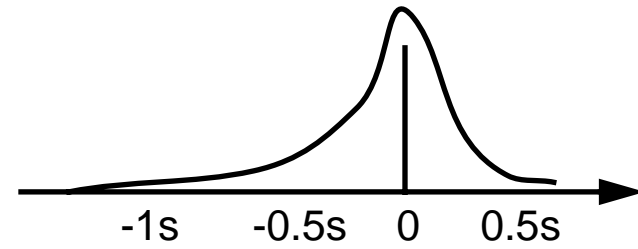

Shisen Sho



Quantum States

classical systems operate on 0 & 1 (in mutual opposition)

quantum systems operate on wavefunctions in which 0 and 1 are orthogonal basis states, possibly in superposition:

$$|\psi\rangle = \alpha|0\rangle + \beta|1\rangle$$

If we measure the wavefunction, we get an answer $|0\rangle$ with probability $|\alpha|^2$, and the answer $|1\rangle$ with probability $|\beta|^2$.

In general, α & β are complex, with $|\alpha|^2 + |\beta|^2 = 1$, but they can be considered real numbers for the applications discussed here.

Quantum Gates

classical

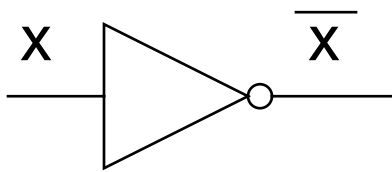

quantum

$$\alpha|0\rangle + \beta|1\rangle \longrightarrow \boxed{X} \longrightarrow \beta|0\rangle + \alpha|1\rangle$$

$$\alpha|0\rangle + \beta|1\rangle \longrightarrow \boxed{Z} \longrightarrow \alpha|0\rangle - \beta|1\rangle$$

$$\alpha|0\rangle + \beta|1\rangle \longrightarrow \boxed{H} \longrightarrow \alpha \frac{|0\rangle + |1\rangle}{\sqrt{2}} + \beta \frac{|0\rangle - |1\rangle}{\sqrt{2}}$$

gate functionality can be expressed as a matrix, eg:

$$\begin{bmatrix} a & b \\ c & d \end{bmatrix} \begin{bmatrix} \alpha \\ \beta \end{bmatrix} = \begin{bmatrix} \alpha' \\ \beta' \end{bmatrix} \text{ subject to only the constraint that both}$$

$|\alpha|^2 + |\beta|^2 = 1$ and $|\alpha'|^2 + |\beta'|^2 = 1$. This implies that the

matrix must be unitary, such that $XX^\dagger = I$.

Quantum controlled-NOT gate

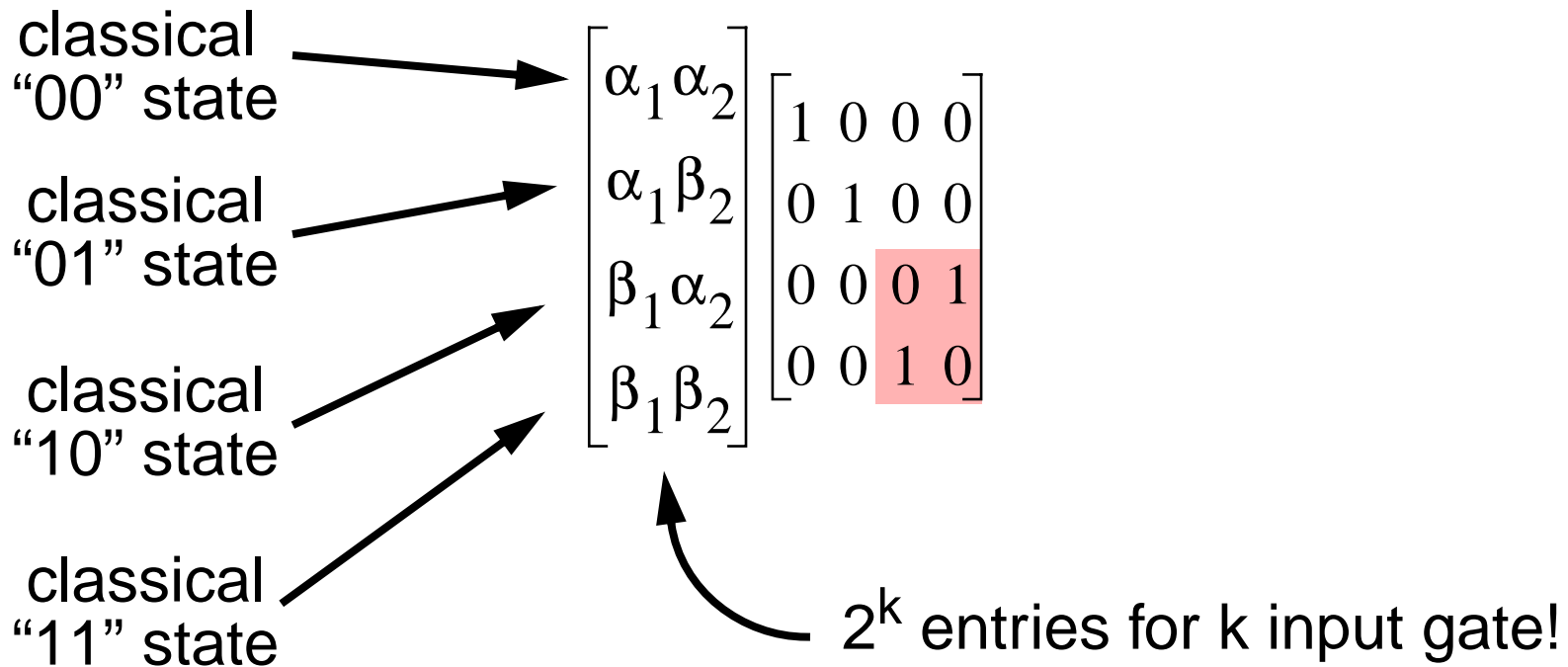
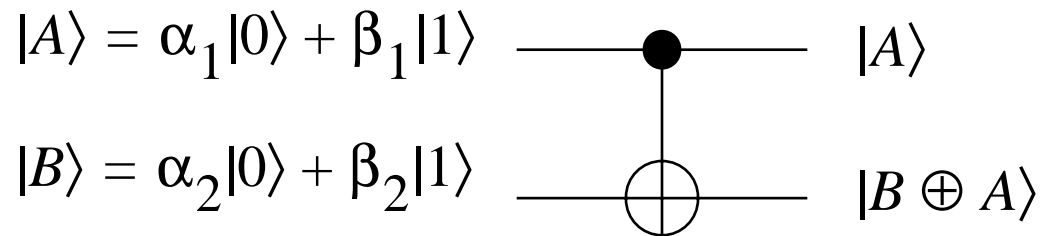

Quantum Tiffoli Gate

Symbol:

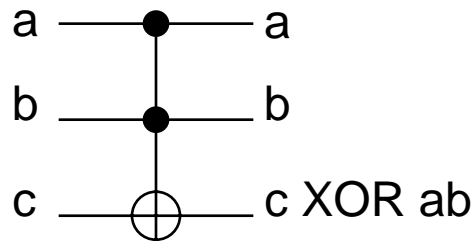

Nand:

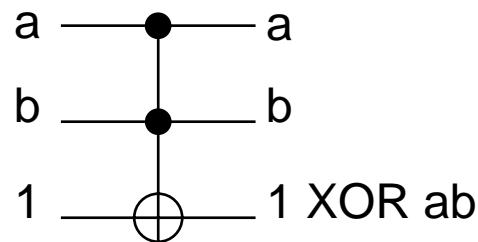

Unitary Matrix

$$\begin{bmatrix} 1 & 0 & 0 & 0 & 0 & 0 & 0 & 0 \\ 0 & 1 & 0 & 0 & 0 & 0 & 0 & 0 \\ 0 & 0 & 1 & 0 & 0 & 0 & 0 & 0 \\ 0 & 0 & 0 & 1 & 0 & 0 & 0 & 0 \\ 0 & 0 & 0 & 0 & 1 & 0 & 0 & 0 \\ 0 & 0 & 0 & 0 & 0 & 1 & 0 & 0 \\ 0 & 0 & 0 & 0 & 0 & 0 & 0 & 1 \\ 0 & 0 & 0 & 0 & 0 & 0 & 1 & 0 \end{bmatrix}$$

Classical Truth Table

Inputs			Outputs		
a	b	c	a	b	c
0	0	0	0	0	0
0	0	1	0	0	1
0	1	0	0	1	0
0	1	1	0	1	1
1	0	0	1	0	0
1	0	1	1	0	1
1	1	0	1	1	1
1	1	1	1	1	0

XOR:

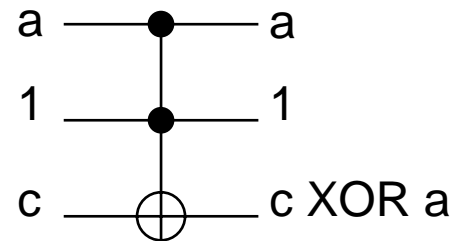

Fanout:

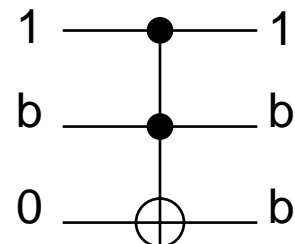

Systems sharing similar dynamic

Unitary
Quantum
Gate

$$\begin{bmatrix} a & b \\ c & d \end{bmatrix} \begin{bmatrix} \alpha \\ \beta \end{bmatrix} = \begin{bmatrix} \alpha' \\ \beta' \end{bmatrix}$$

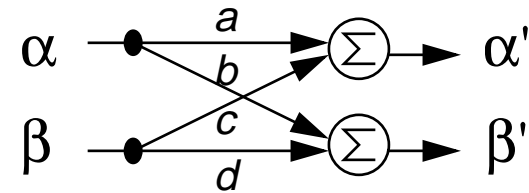

Free space
light/radio/sound
propagation

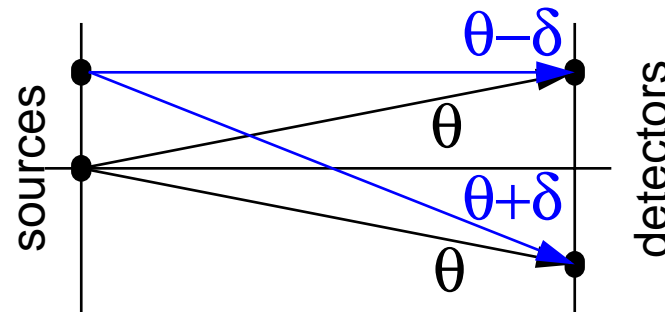

Microwave/Optical
power combiner

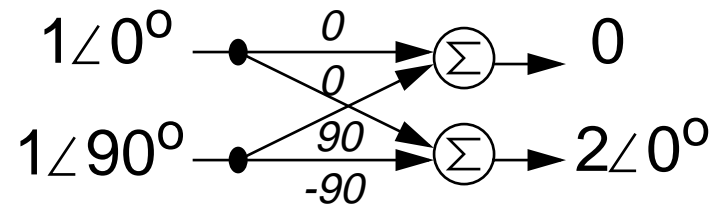

Systems sharing similar dynamic

Nerve impulse propagation in the cortex

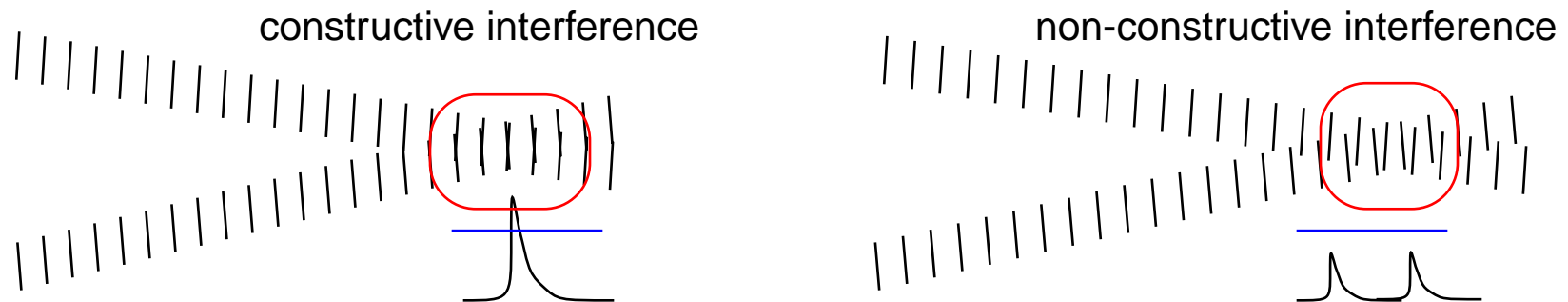

“Even with a simple stimulus... neurons will indeed gradually be corralled into a working network, like a stone generating ever wider ripples.” “Even a simple light shone in the direction of a cat will, as a stone in a puddle, activate an assembly of an estimated 10 million neurons within its outer perimeter with a quarter of a second! What is more, the degree of activity of the neuron assembly decays exponentially as the leading edge spreads out...”

Broad Overview of Algorithm

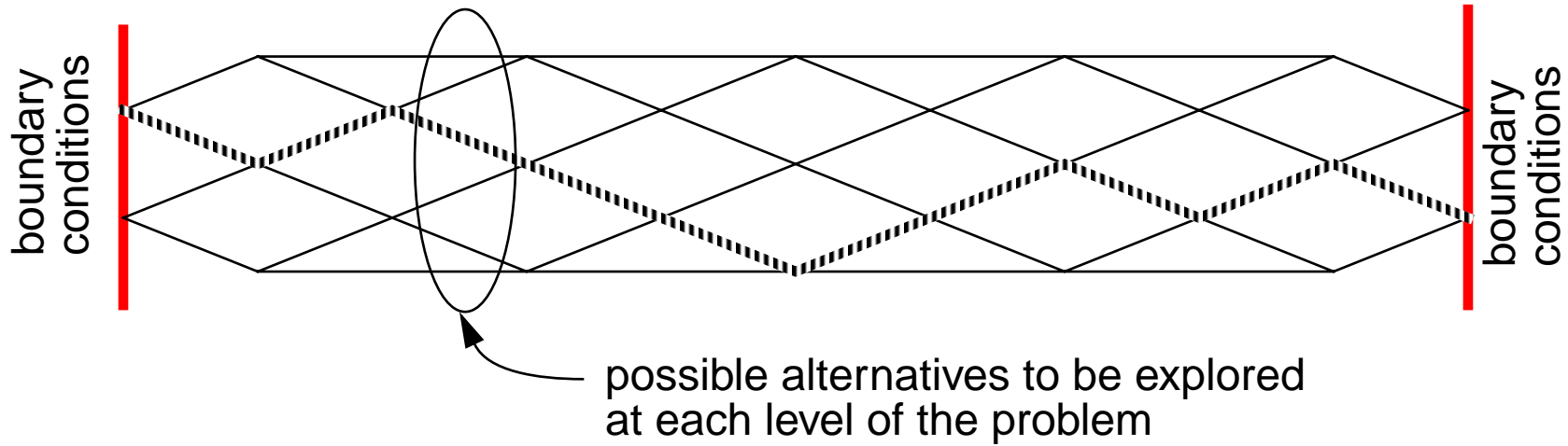

- Symbolic, rational thought proceeds by “either-or” Aristotelian logic. It can only find a global optimum by exhaustive exploration of the huge combinatorial space.
- Intuitive thought proceeds by “yes-and” quantum logic. It sets up a set of unitary transformations homologous to the problem space and iterates until the highest gain mode “lases”.

Simulation of Half Adder

classical:

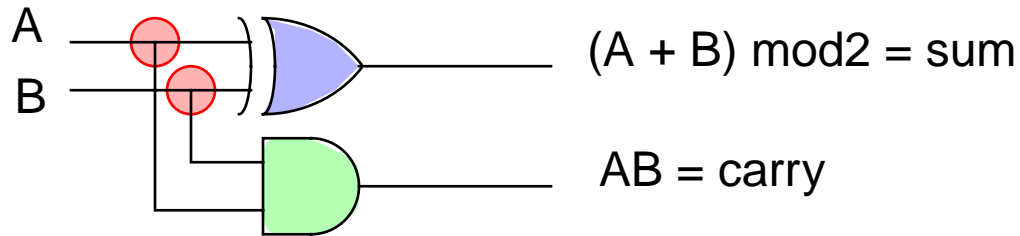

quantum implementation with Toffoli gates

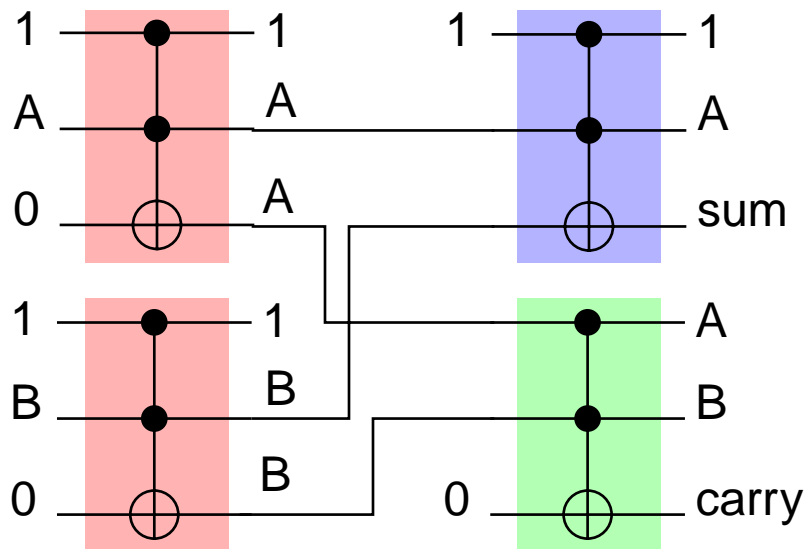

A	B	sum	carry
0	0	0	0
0	1	1	0
1	0	1	0
1	1	0	1

basic simulator algorithm

each node in simulator stores a complex value equal to $\alpha + \beta i$, with α^2 giving the probability of a classical zero and β^2 giving the probability of a classical one.

At each time step, the inputs of every gate are transformed and summed into the state of the output nodes.

Simultaneously, the output of every gate is back-transformed and summed into the state of the input nodes.

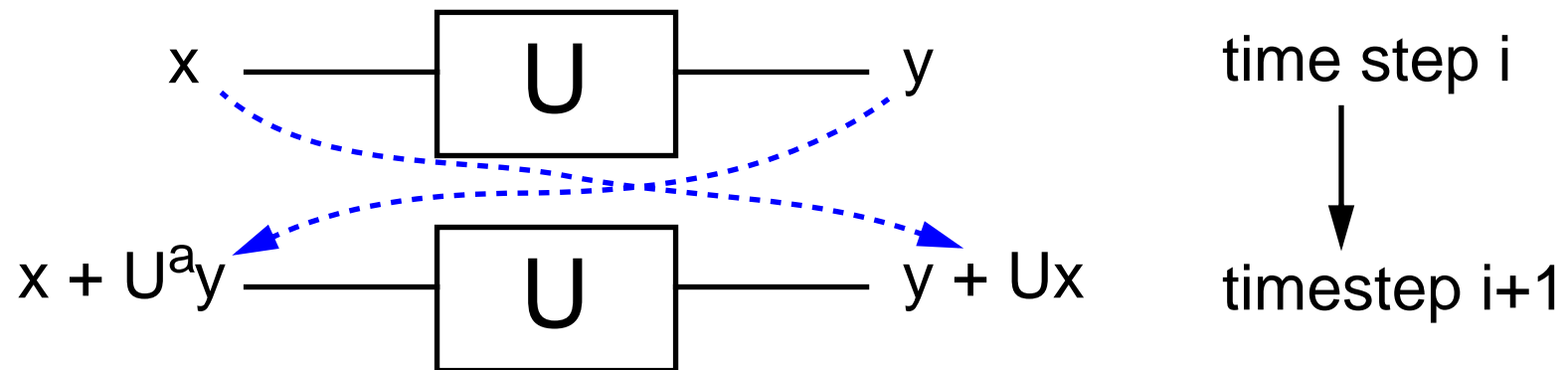

basic simulator algorithm continued

After each time step, all the nodes are normalized to unity magnitude.

To ensure a classical result, the normalization algorithm is adjusted to gradually force all nodes to take on a quantized result halfway through the simulation.

This is analogous to “measurement”. By forcing the system into a classical state, an answer is achieved, but any further evolution of the system state is destroyed.

Simulation #1, set the inputs, read output

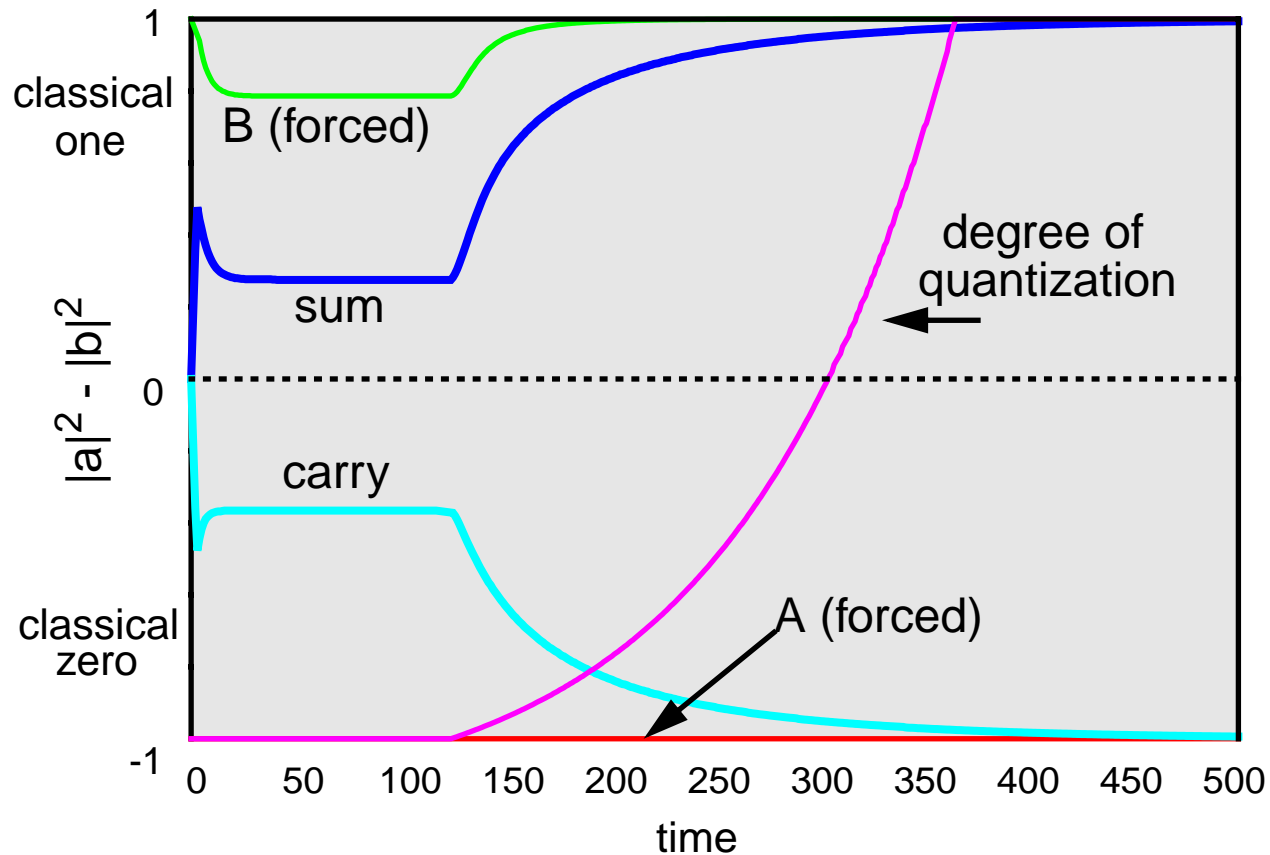

A	B	sum	carry
0	0	0	0
0	1	1	0
1	0	1	0
1	1	0	1

Network rapidly converges to correct solution

Simulation #2, set outputs, read input

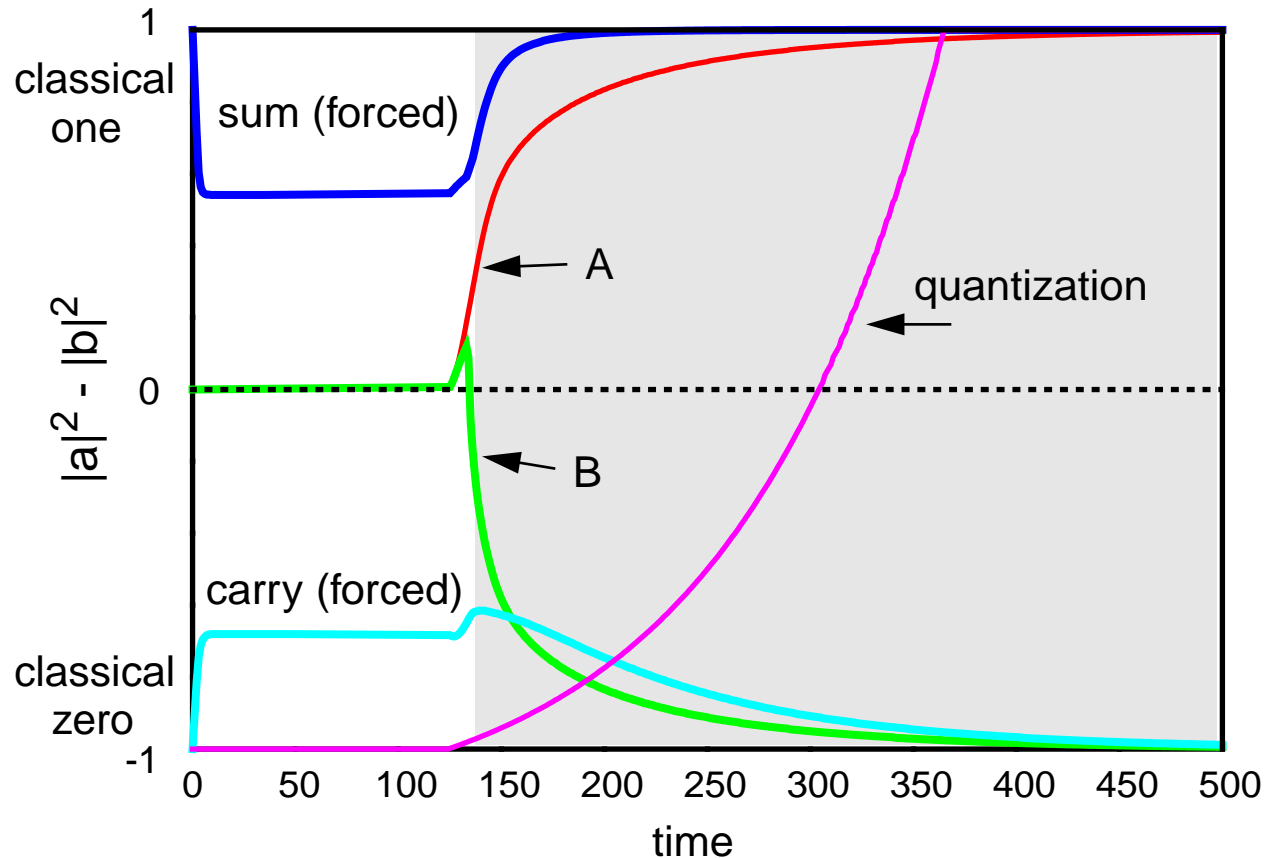

A	B	sum	carry
0	0	0	0
0	1	1	0
1	0	1	0
1	1	0	1

Slow quantization allows network to continuously stay in equilibrium during transition to classical logic values and leads to correct solution within gray shaded region.

Simulation #3, set outputs, read inputs

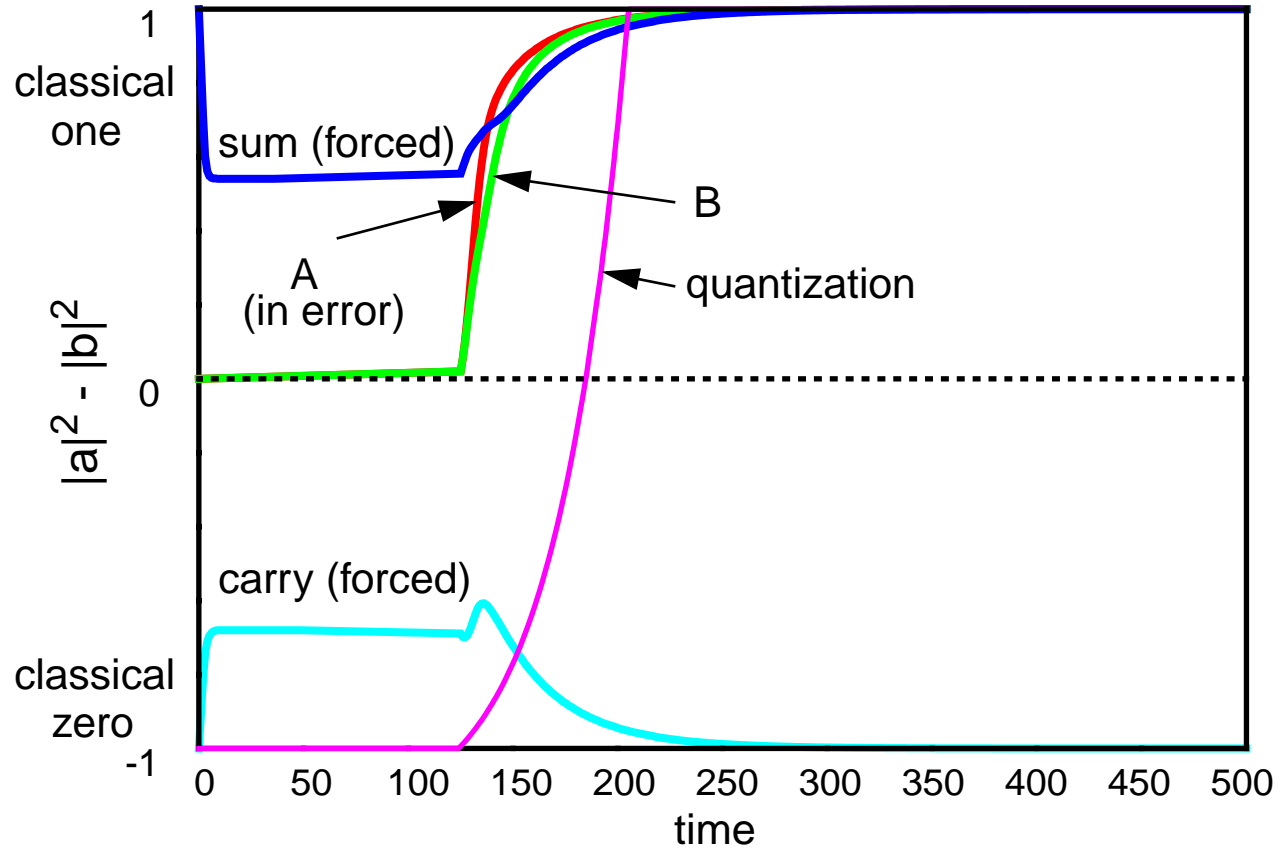

A	B	sum	carry
0	0	0	0
0	1	1	0
1	0	1	0
1	1	0	1

Overly rapid quantization exceeds the ability of the network to propagate changes between nodes and forces network into non-logical classical state.

Simulation #4, set one input, one output

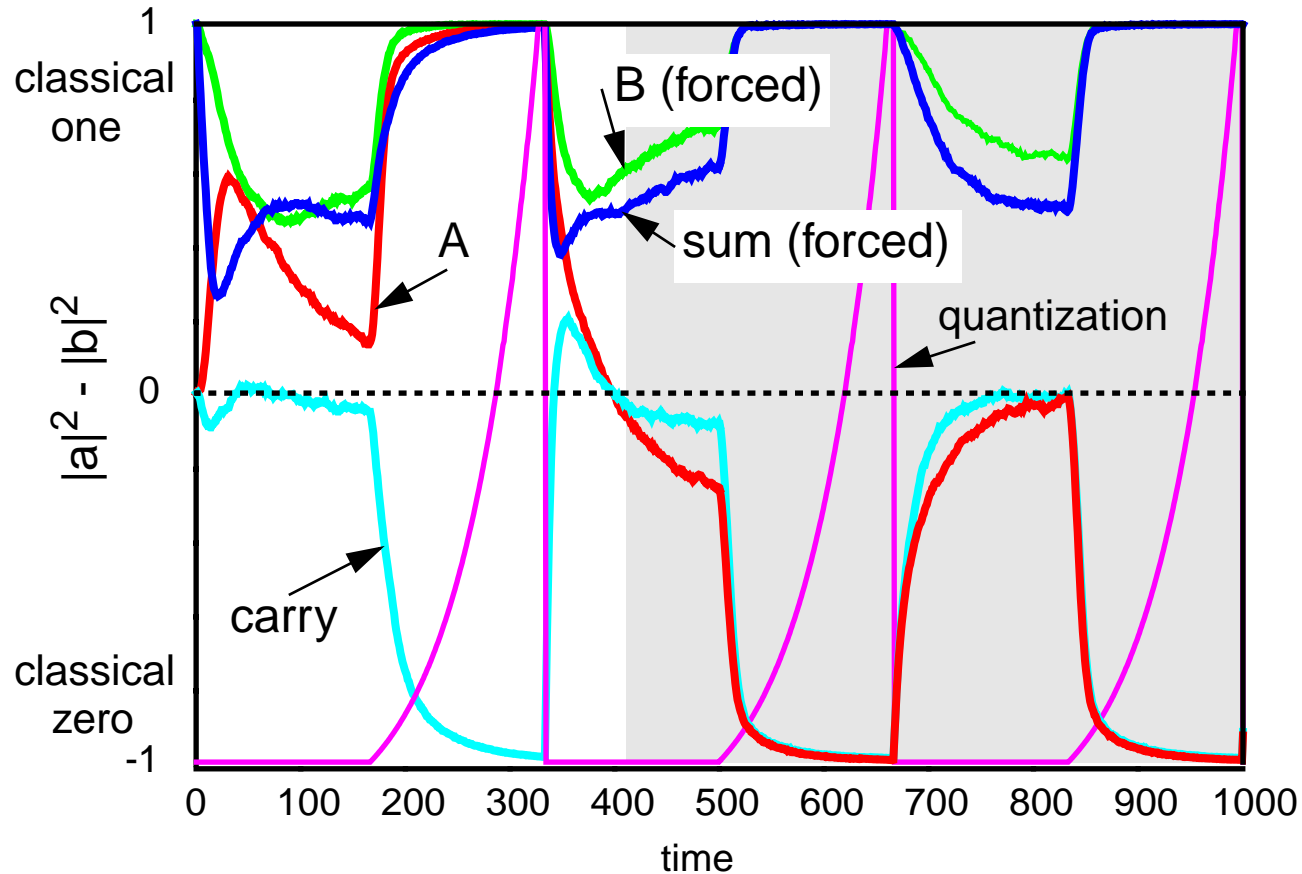

A	B	sum	carry
0	0	0	0
0	1	1	0
1	0	1	0
1	1	0	1

Network fails to compute proper result on first quantization, but achieves correct answer (gray region) on second iteration.

Summary of Quantum Computation Analogy

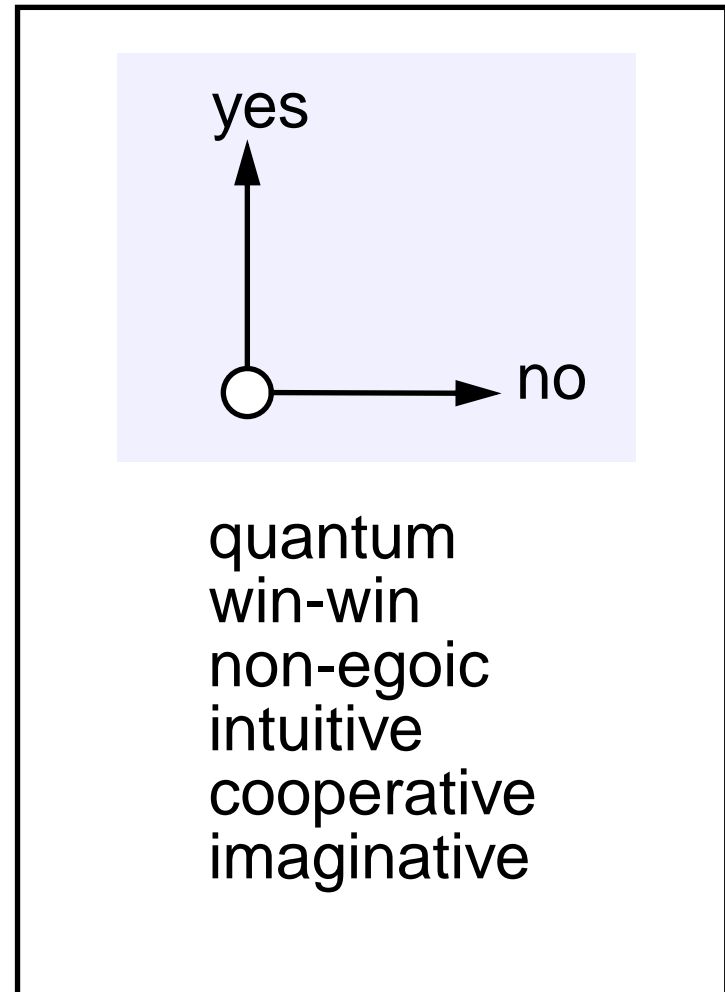
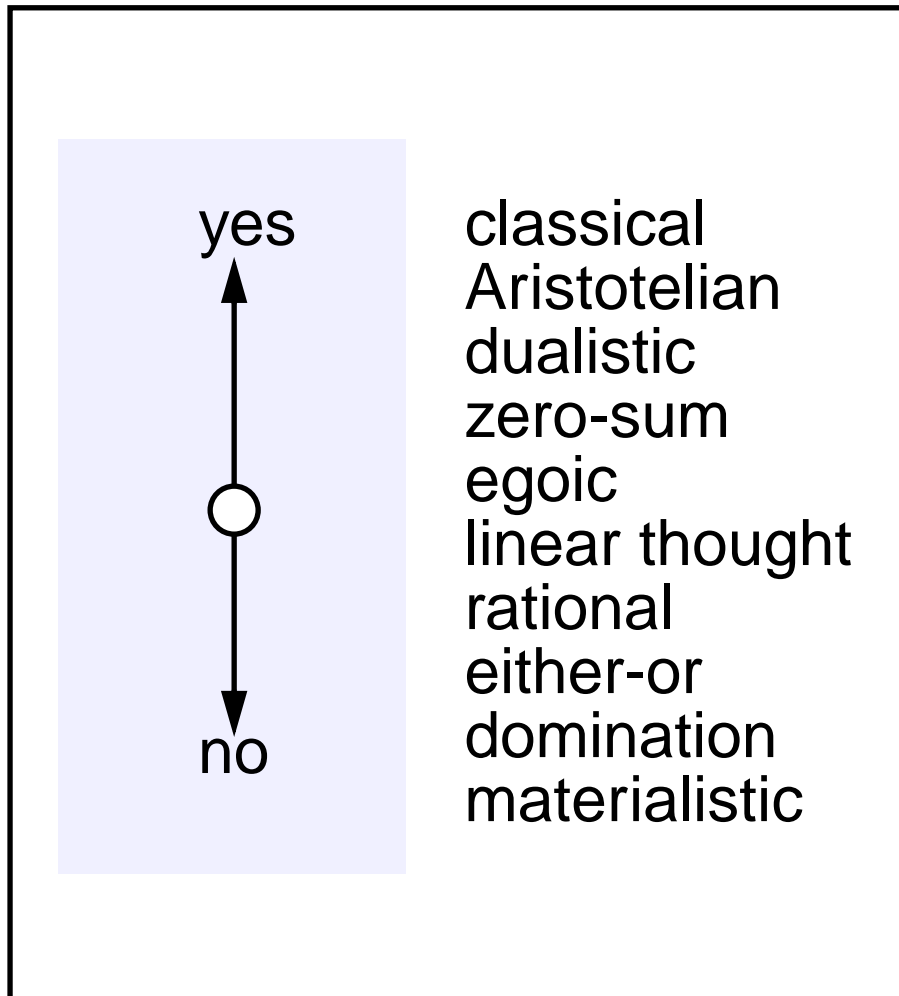

Quantum Computation

- Choose a quantum system for the computation
- Metaphorically map the “real world” problem into the dynamics of the quantum computation
- set the initial state of the system
- perform the unitary evolution of the quantum state
- read the final state of the quantum system
- check the results using a Classical system

instruction

information

contemplation

revelation

verification

rational

intuitive

rational

Wait a minute...

I thought you couldn't get quantum speed up with a classical process?

Ian Walmsley reported at CLEO/QE in May that he and his colleagues had built a working system proving that classical interference such as that between intersecting light waves, could lead to a computation method analogous to the interference aspect of quantum computing.

David A. Meyer of the University of California, San Diego and some other theorists had previously argued that a computer using classical physics can perform as well as any quantum computer in some calculations that involve only interference. Until now, however, there's been no actual interference-based classical computer for testing the idea. The Rochester team's work has experimentally verified this theory, Meyer says.

Some suggestions to improve creativity

- Try to make the set of possible brain pathways as complete as possible.
- Defer collapsing the wavefunction as long as possible to allow probing the set of possibilities.
- Try not to map everything as dualities. Sometimes an N-way alternative is a better map to the data.
- Pay close attention to any information that appears to be at odds with your current “world model”. This information is critical to maintaining accuracy.
- Don't fall into the trap of suppressing contradictory input.
- Be willing to change yourself and your problem definition to work with what is possible.
- Look for global optima rather than short term gain.

Western culture encourages left brain dominance

“By the time the child can draw more than a scribble, by age three or four years, an already well-formed body of conceptual knowledge formulated in language dominates his memory and controls his graphic work... Drawings are graphic accounts of essentially verbal processes. As an essentially verbal education gains control, the child abandons his graphic efforts and relies almost entirely on words. Language has first spoiled drawing and then swallowed it up completely.”

- Written in 1930 by psychologist Karl Buhler

Drawing on the Right side of the Brain



“Draw a Person”



“Sketch Stravinski”

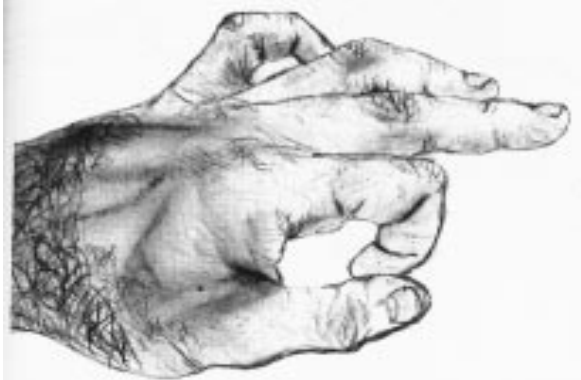

“Draw a Person”



“Sketch Stravinski upside-down”



Ear Dancing

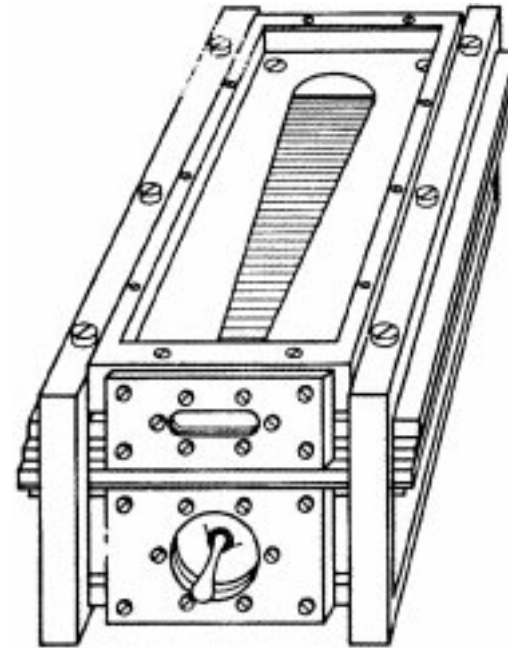
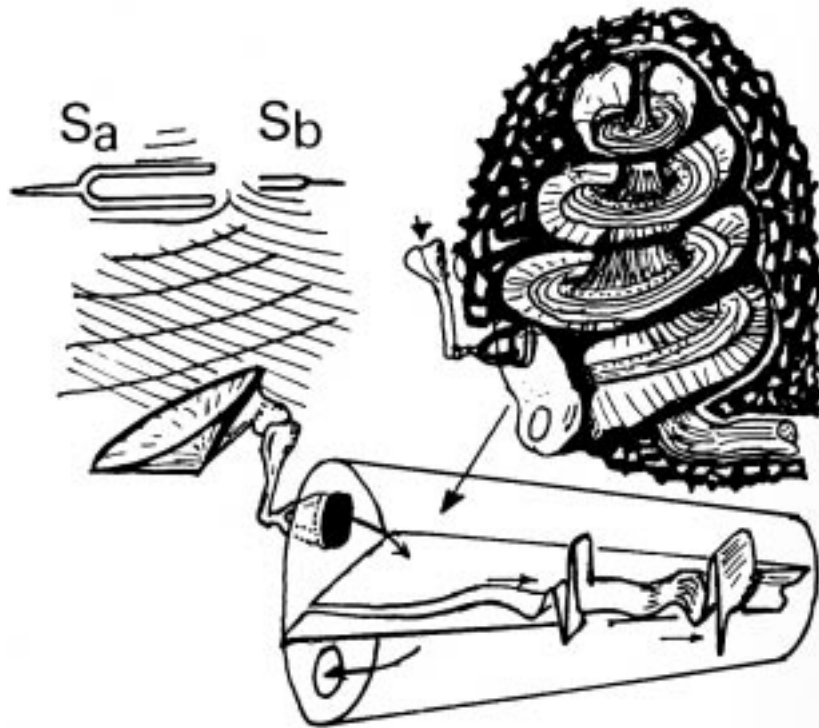

analog of cochlea built to test Q

The ear is *not* a passive Fourier analyzer. It learns to “dance” with incoming signals using critical feedback to increase the Q of the cochlear resonance. “Ringing” ears actually *emit* sound! Perfect pitch may be possible by attending to interference patterns rather to “pitches”.

After David T. Kemp, "New Discoveries about the Ear", Proceedings of the Royal Institution V59, 1987 pp. 185-213.

Balance in the Body

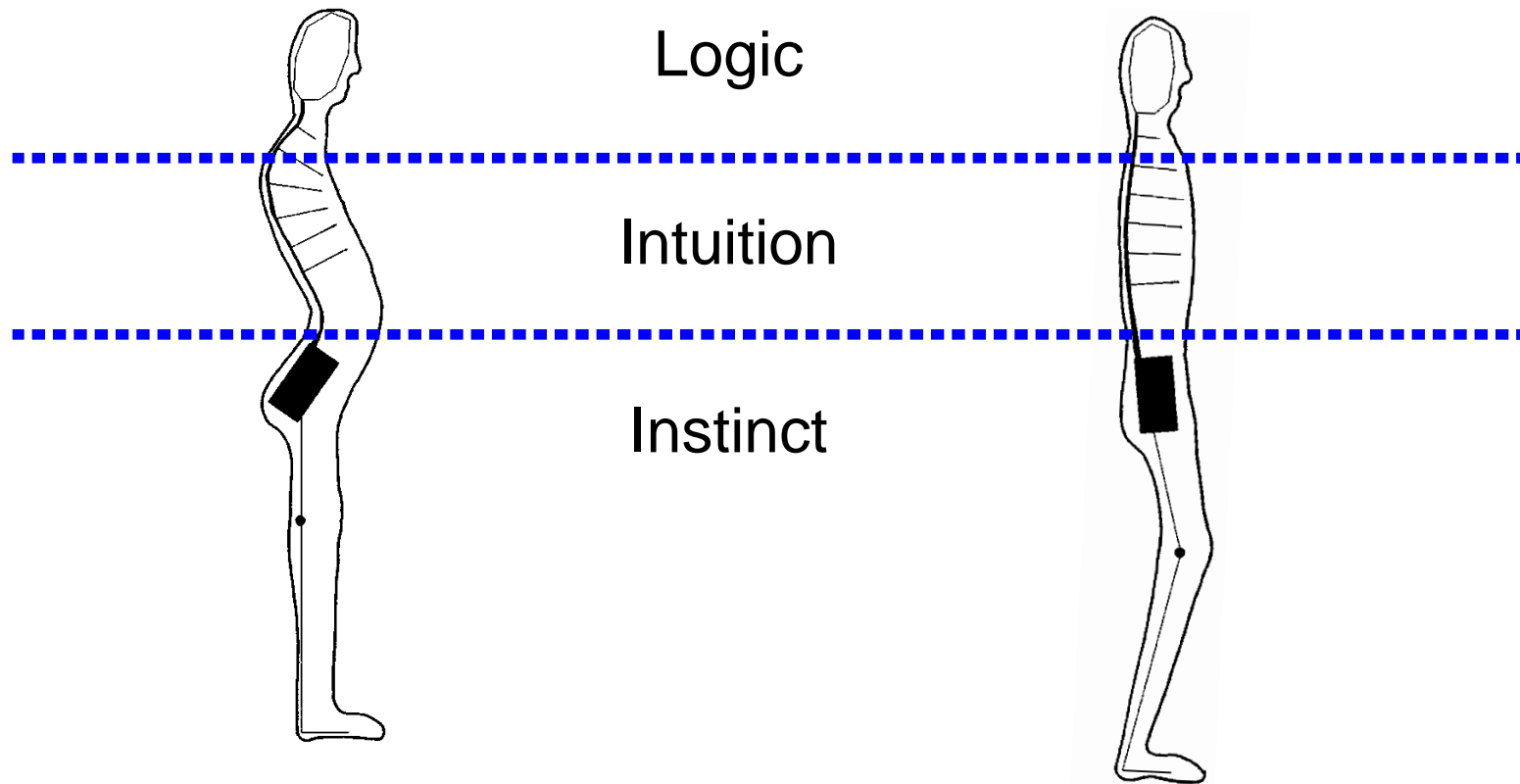

“Three worlds, two bridges”
tension stops communication

Elements from other systems

pure meditation: goes directly at insight into brain function and to see that symbol formation is a secondary process

meditation on the breath: directly see that the opposing muscle groups that are responsible for in/out breath are actually one entity that doesn't need to fight itself

yoga: works on static stretching of opposing (dualistic) muscle groups to reduce conflict between them

pranayama: breathing with controlled holding of the breath on either in/out cycle to train opposing systems not to panic - leads to faster realization of the unity of the in/out breath process

Learning the truth of “the two being one” through any technique makes it easier to apply to any other domain.

Some sound-bites to “enlightenment”

- A Taoist model: ying-yang balance, don't cut the primal block (Pu).
- A Hindu model: “neti-neti”, literally, “not this, not that”, meaning that the truth is not found in particulars, but in wholes.
- A Buddhist model: 1) find two things in apparent opposition to each other, 2) meditate on the dynamic until you can see the pair as one entity. 3) now find the thing that is opposite to that. Go to step 1).
- A Christian model: Love your brother as yourself (because he really is you, in disguise).

The fallacy of unlimited growth

Exponential growth, no limits:

$$\frac{dN}{dt} = rN, \text{ leads to the solution: } N(t) = N_0 e^{rt}.$$

Real ecosystems have carrying limits, K:

$$\frac{dN}{dt} = rN \left[1 - \frac{N}{K} \right], \text{ leading to the so-called Sigmoidal-Curve}$$

$$\text{solution: } N(t) = \frac{KN_0}{N_0 + (K - N_0)e^{-rt}}.$$

or, maybe a picture would be clearer...

Sigmoidal vs Exponential Growth

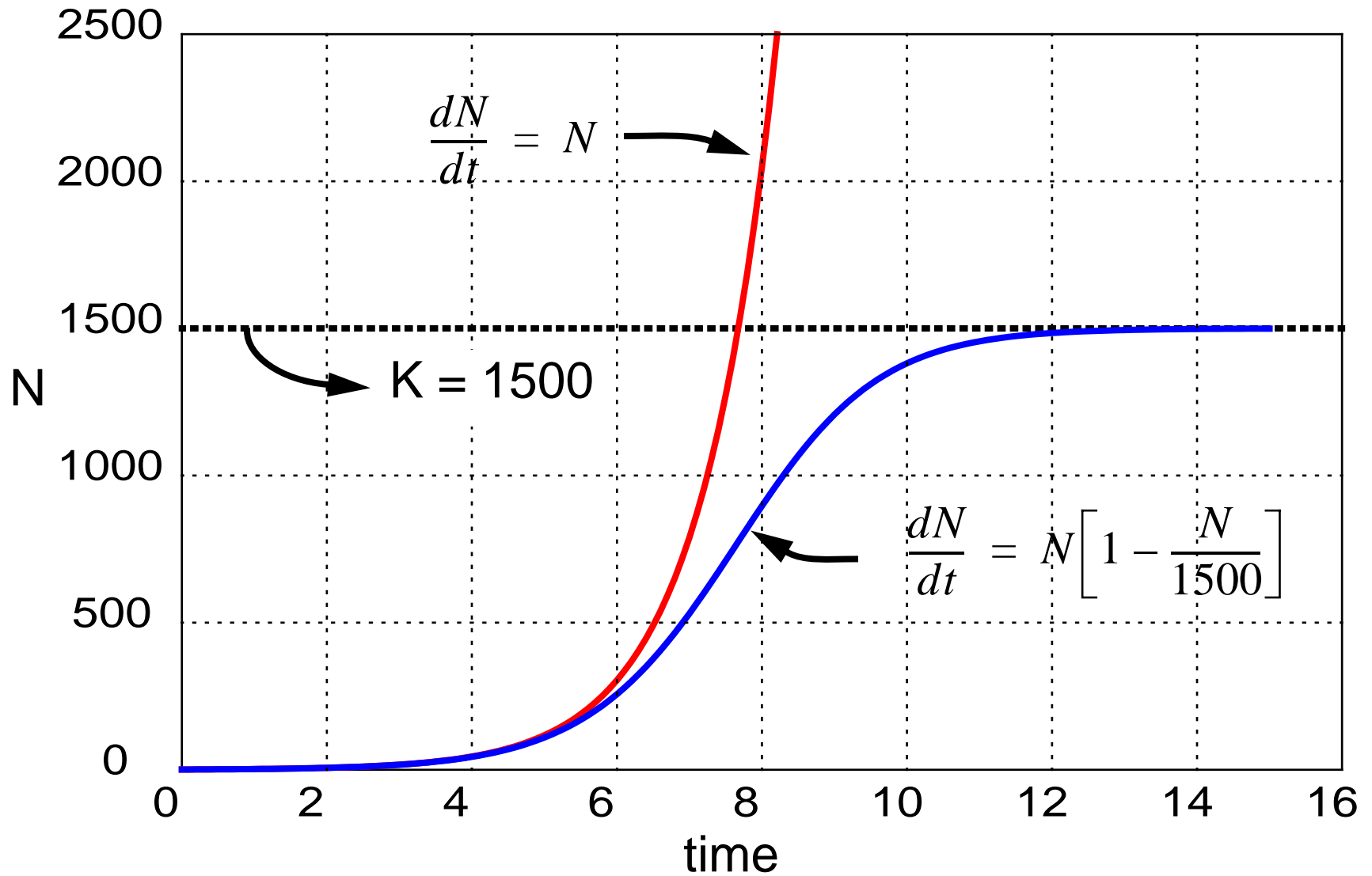

Sigmoid with response lag (L)

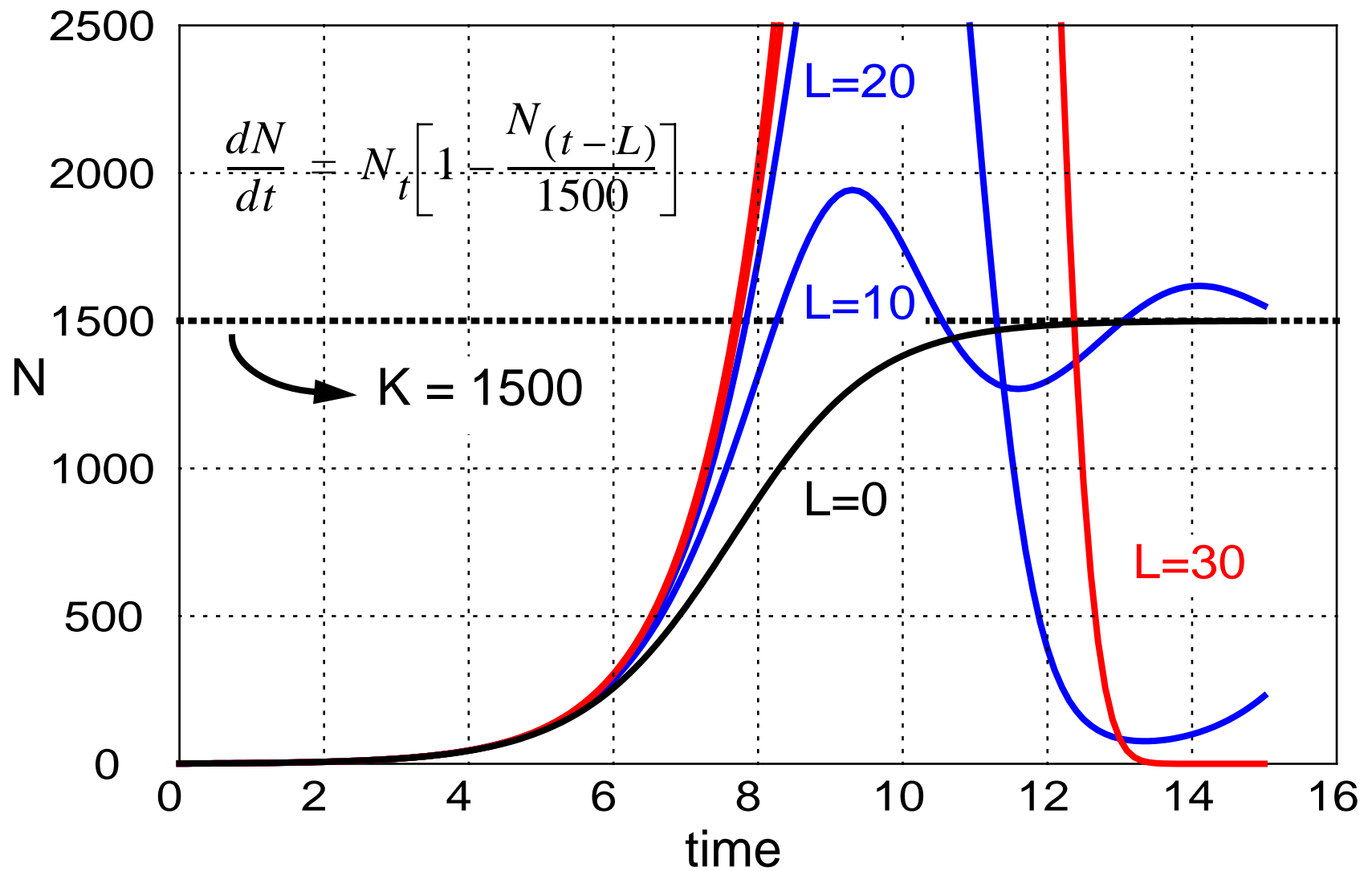

Example of Logistic Growth

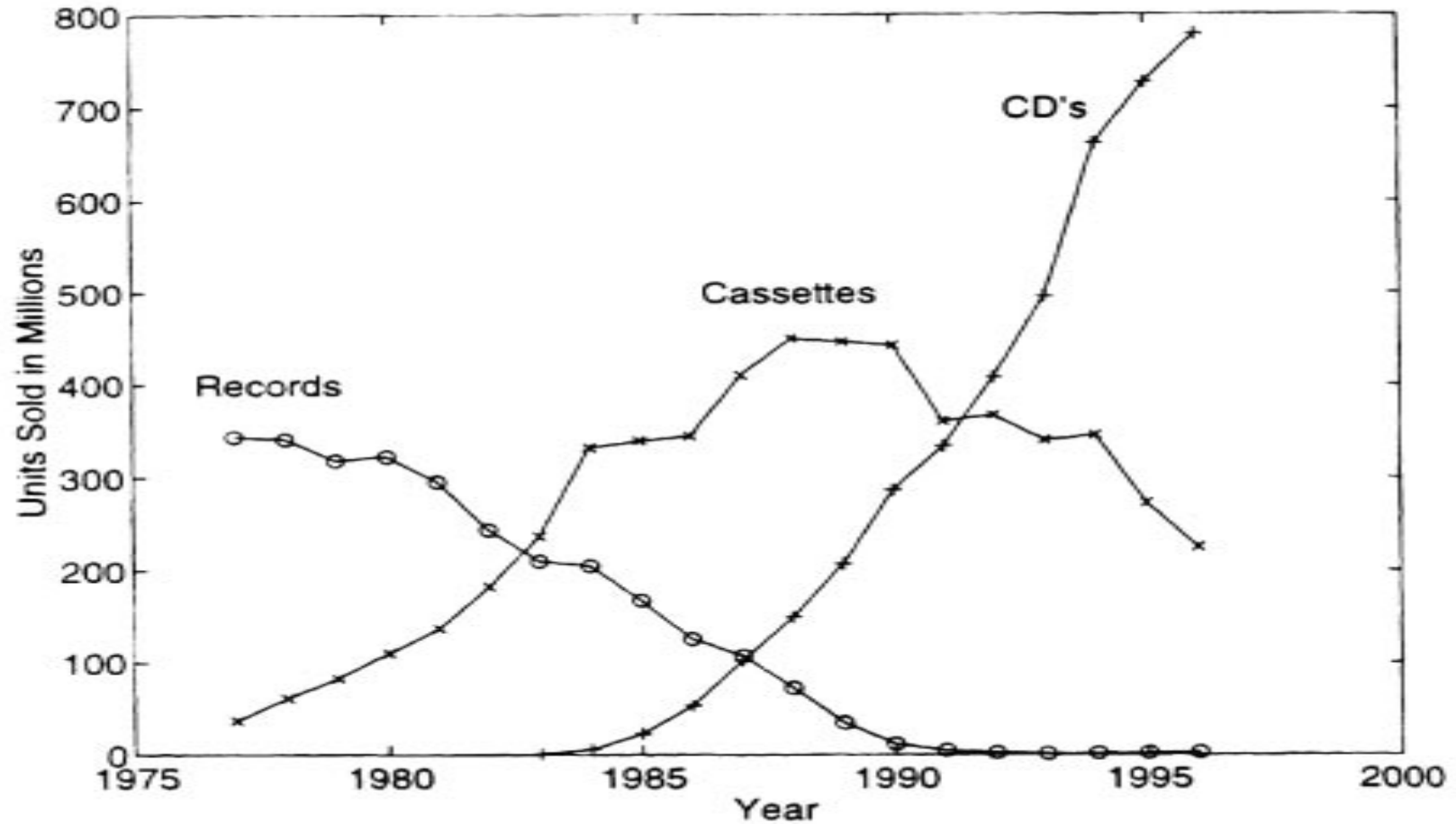

From Meyer, Jung, Ausubel, "A Primer on Logistic Growth and Substitution", Technological Forecasting & Social Change", 1999, V61,3 p264

Fisher-Pry Transform

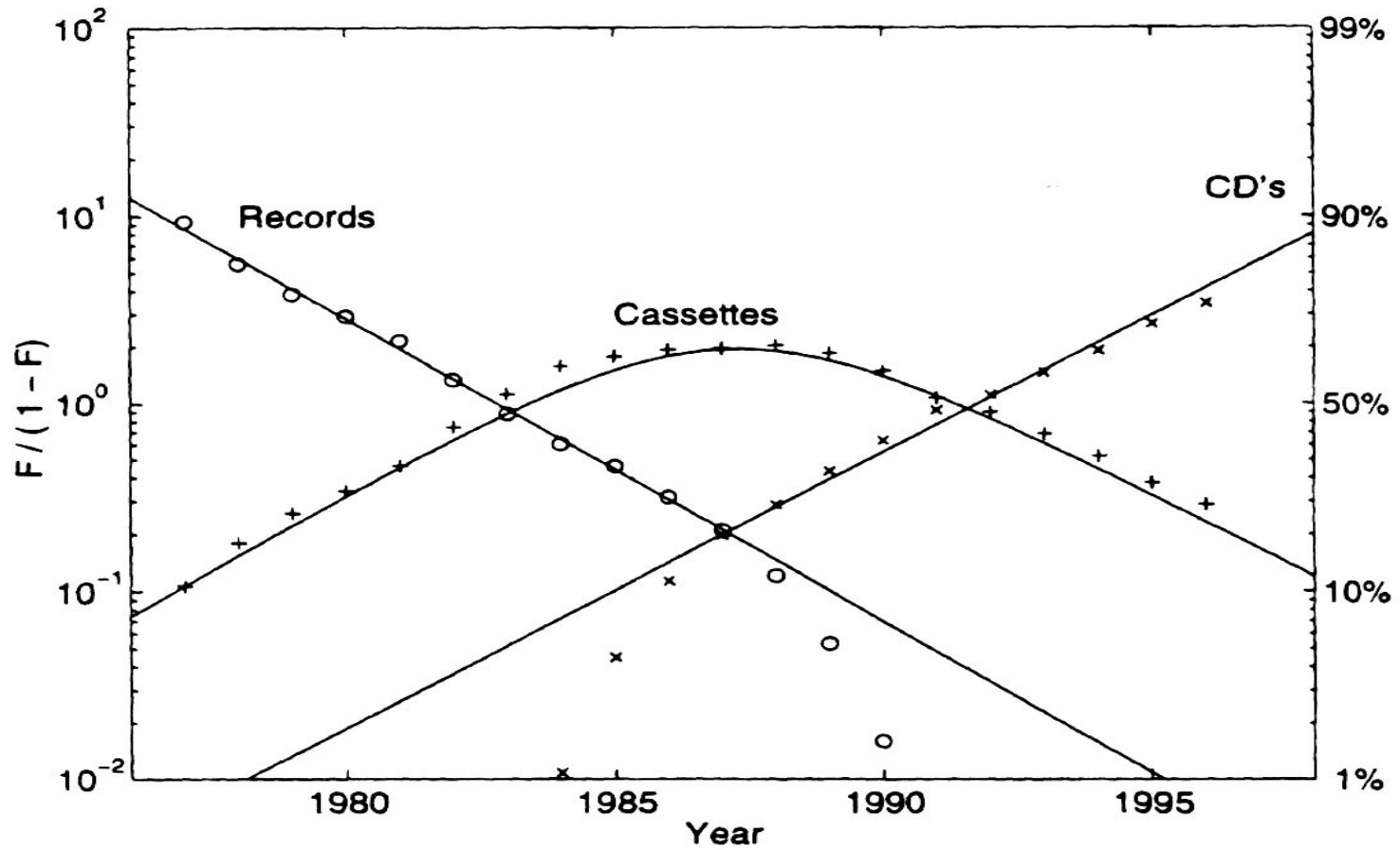

From Meyer, Jung, Ausubel, "A Primer on Logistic Growth and Substitution", Technological Forecasting & Social Change", 1999, V61,3 p266

Example of Logistic Growth

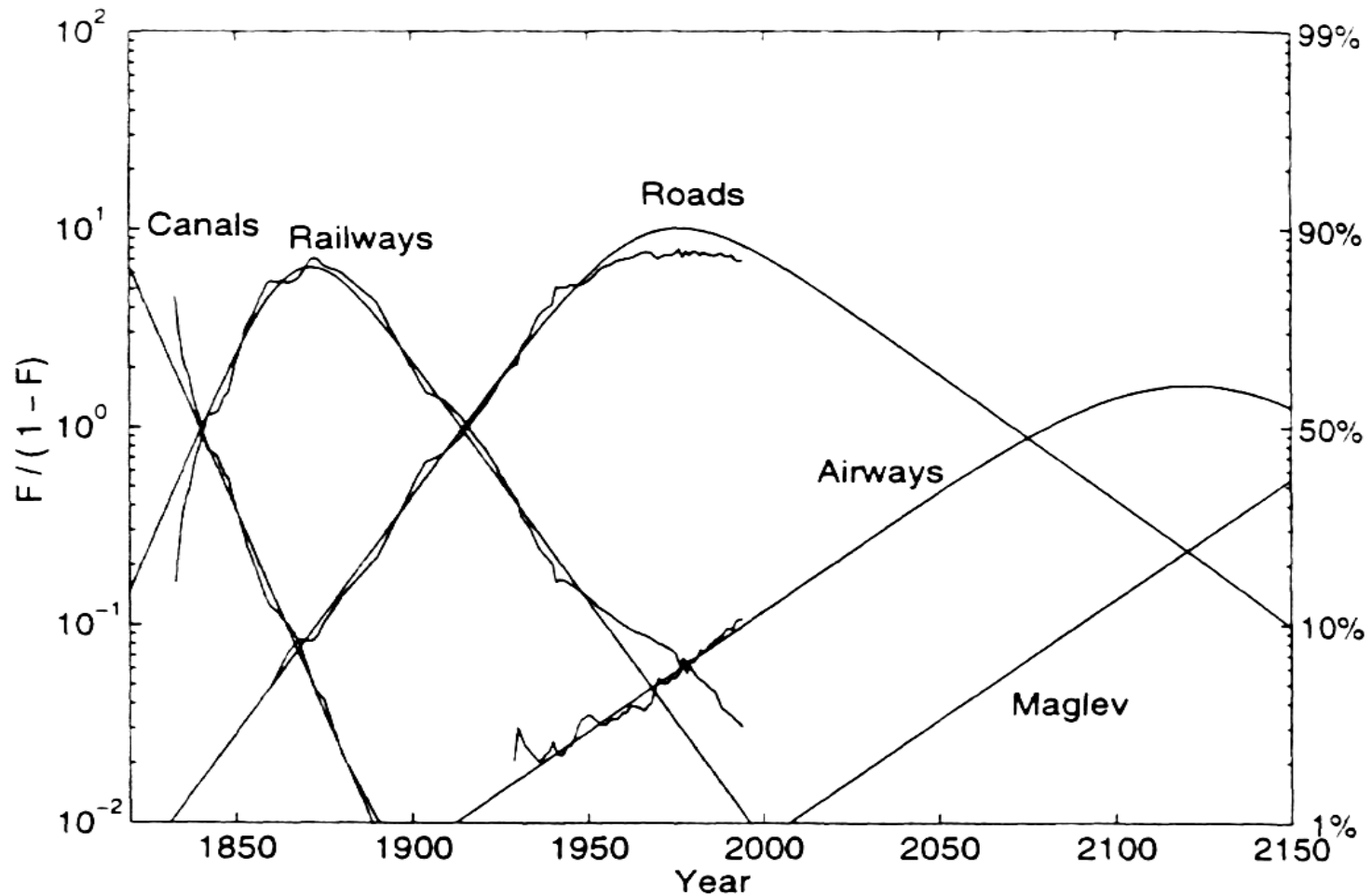

From Meyer, Jung, Ausubel, "A Primer on Logistic Growth and Substitution", Technological Forecasting & Social Change", 1999, V61,3 p266

The Growth of Ethernet

cumulative worldwide shipments

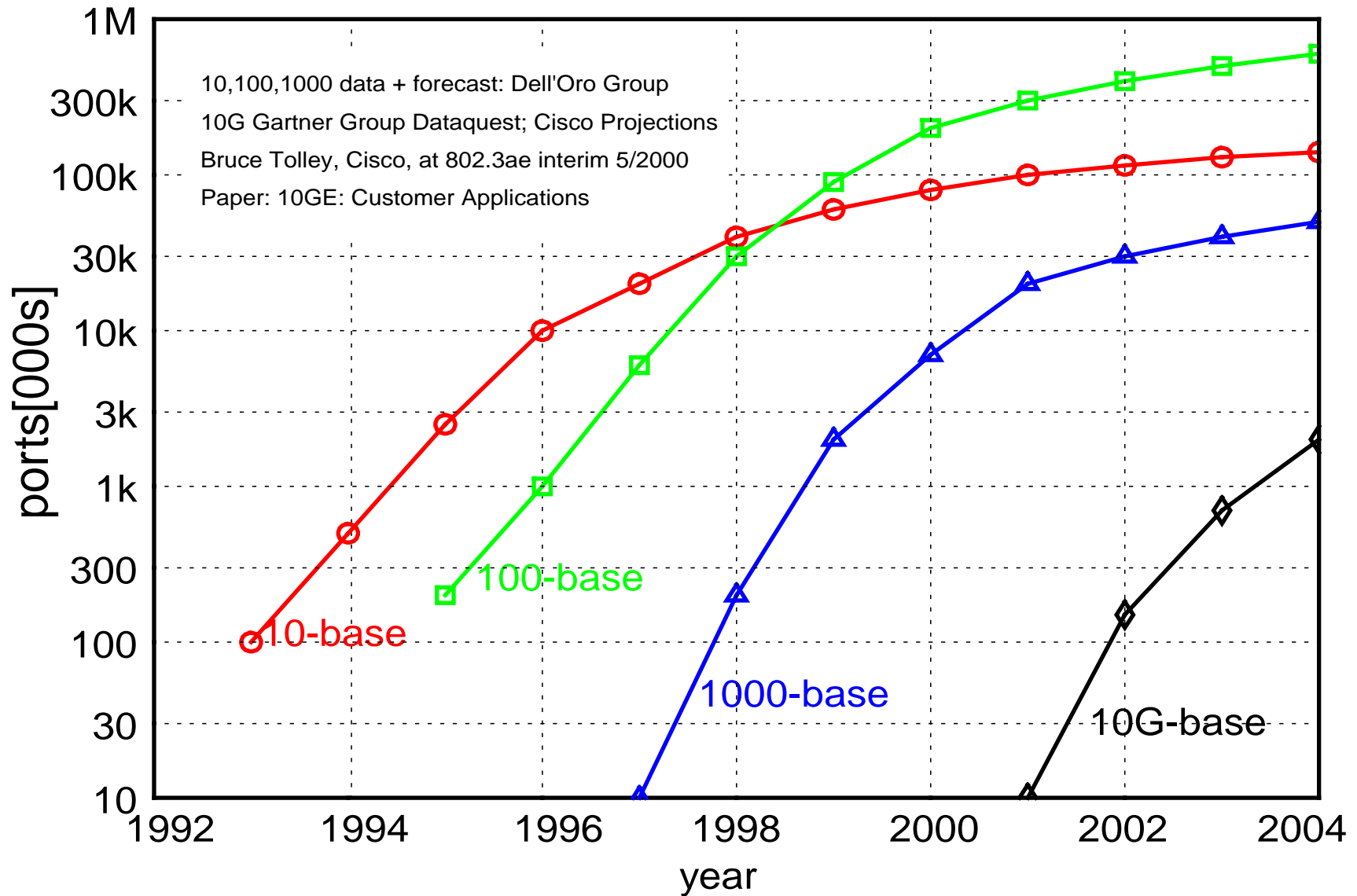

Global Ethernet Annual Revenue

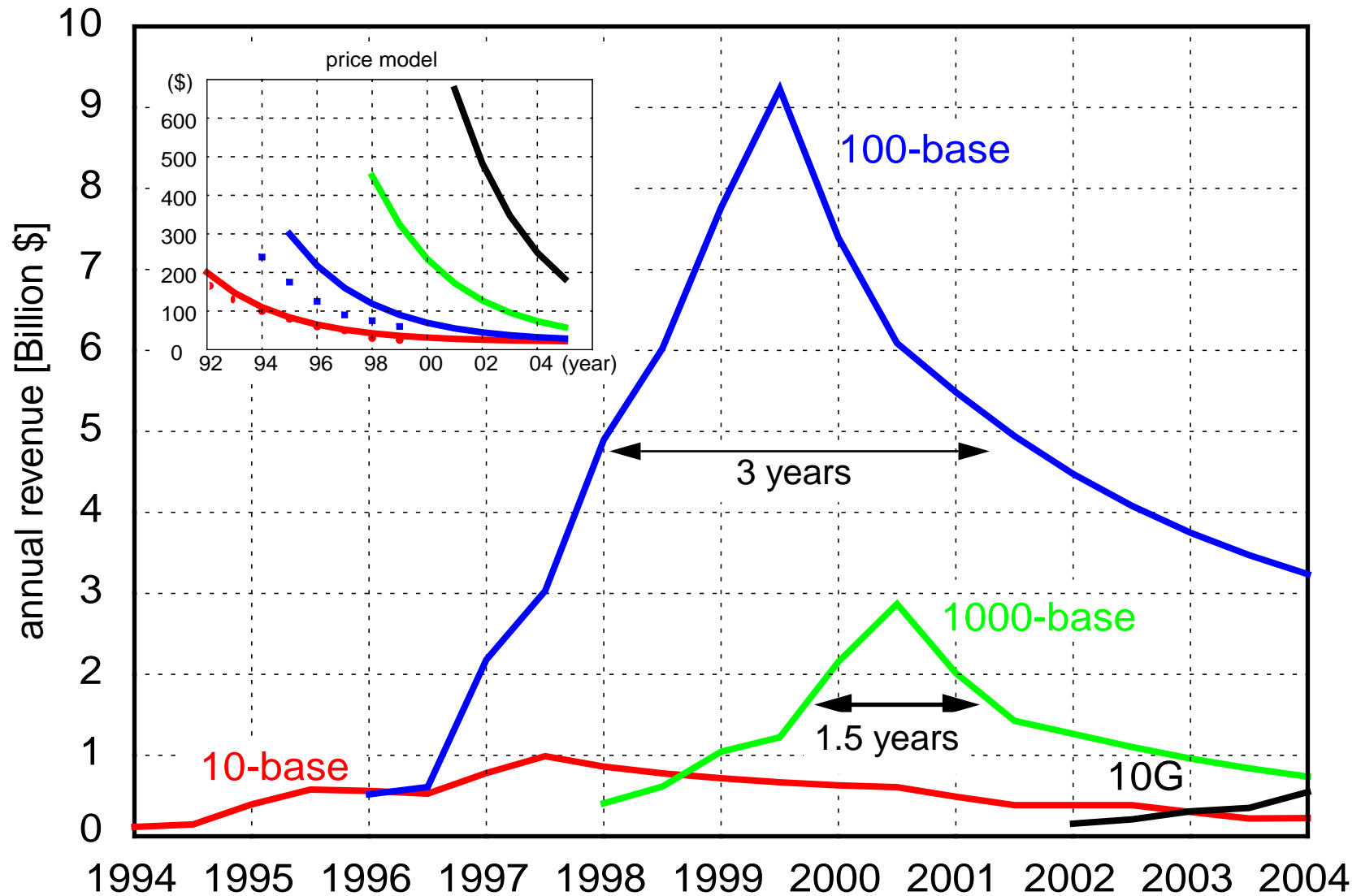

Daisy World

- The solar flux increases 7% per billion years, yet the global temperature has remained constant for the last 3.5 billion years.
- Oxygen levels, temperature, ocean salinity are all in non-equilibrium state and appear to be dynamically “managed” at a global scale.
- Watson and Lovelock proposed a simple model in 1983 which demonstrates the basic homeostatic temperature regulation mechanism.
- The basic model posits two species on the planet, white daisies which reflect sunlight, and black daisies which absorb sunlight. Both daisies grow best in the same limited temperature range with an optimum at 22.5C.

Daisy World

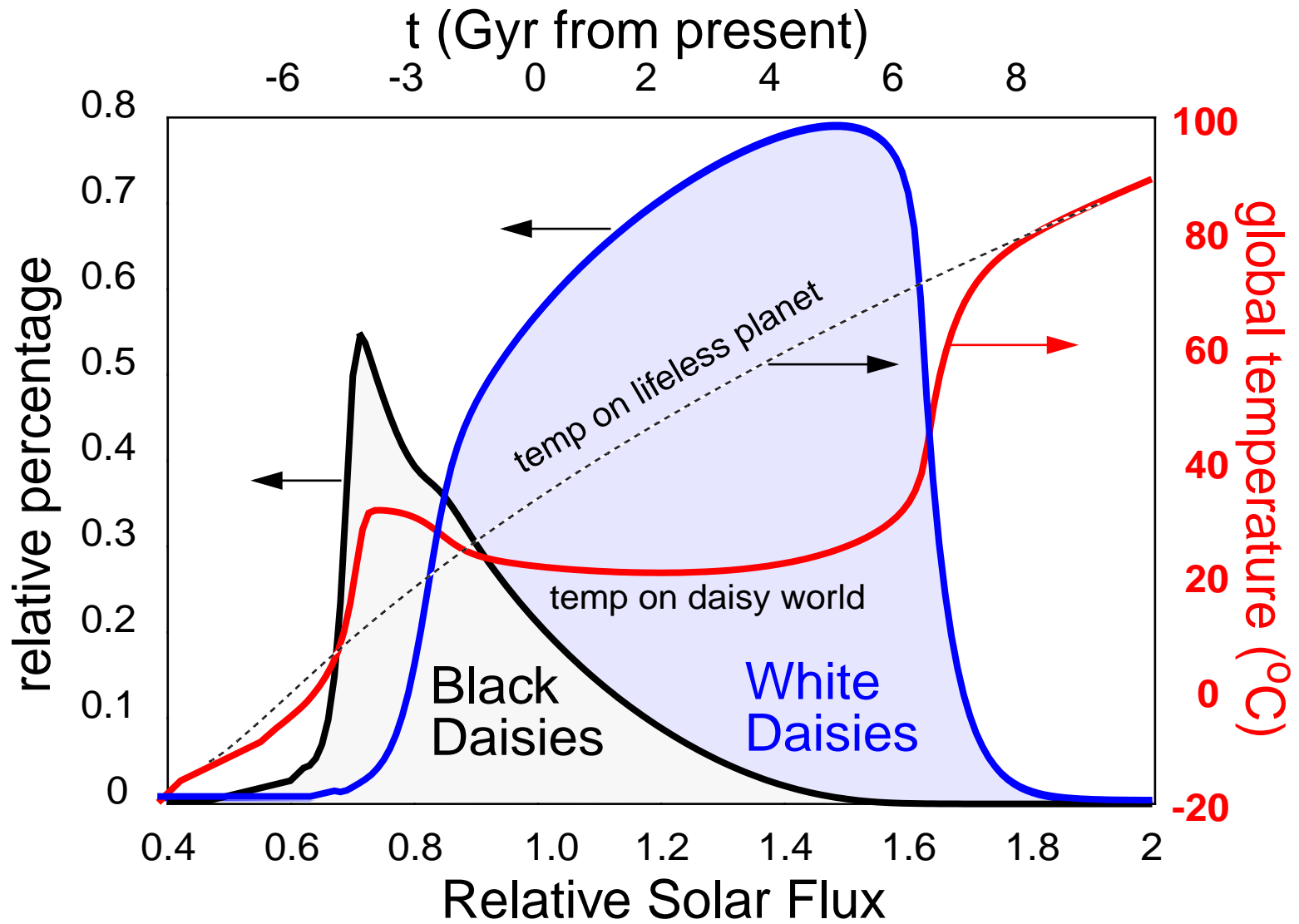

Daisy World

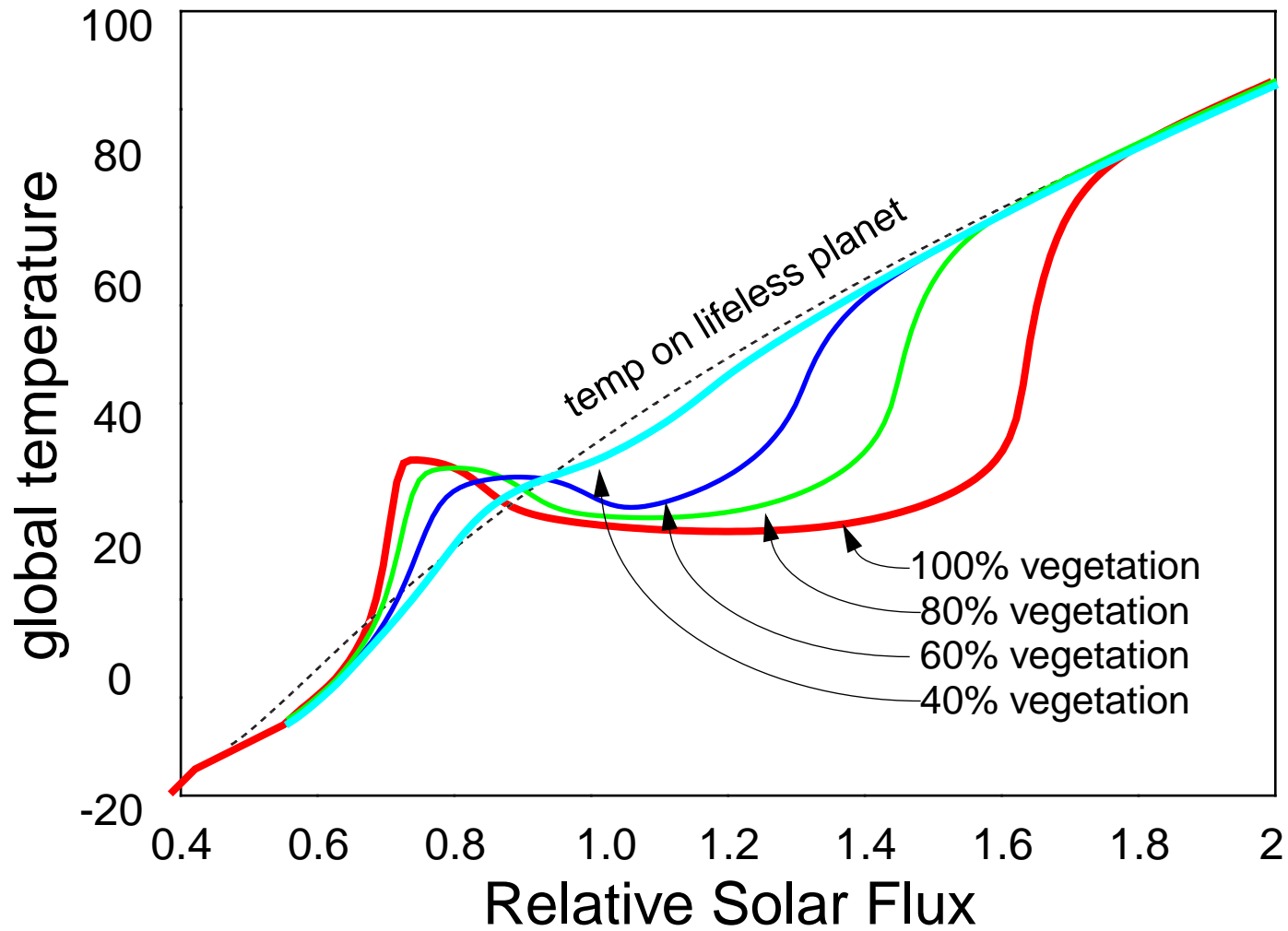

Daisy World with Fragmentation

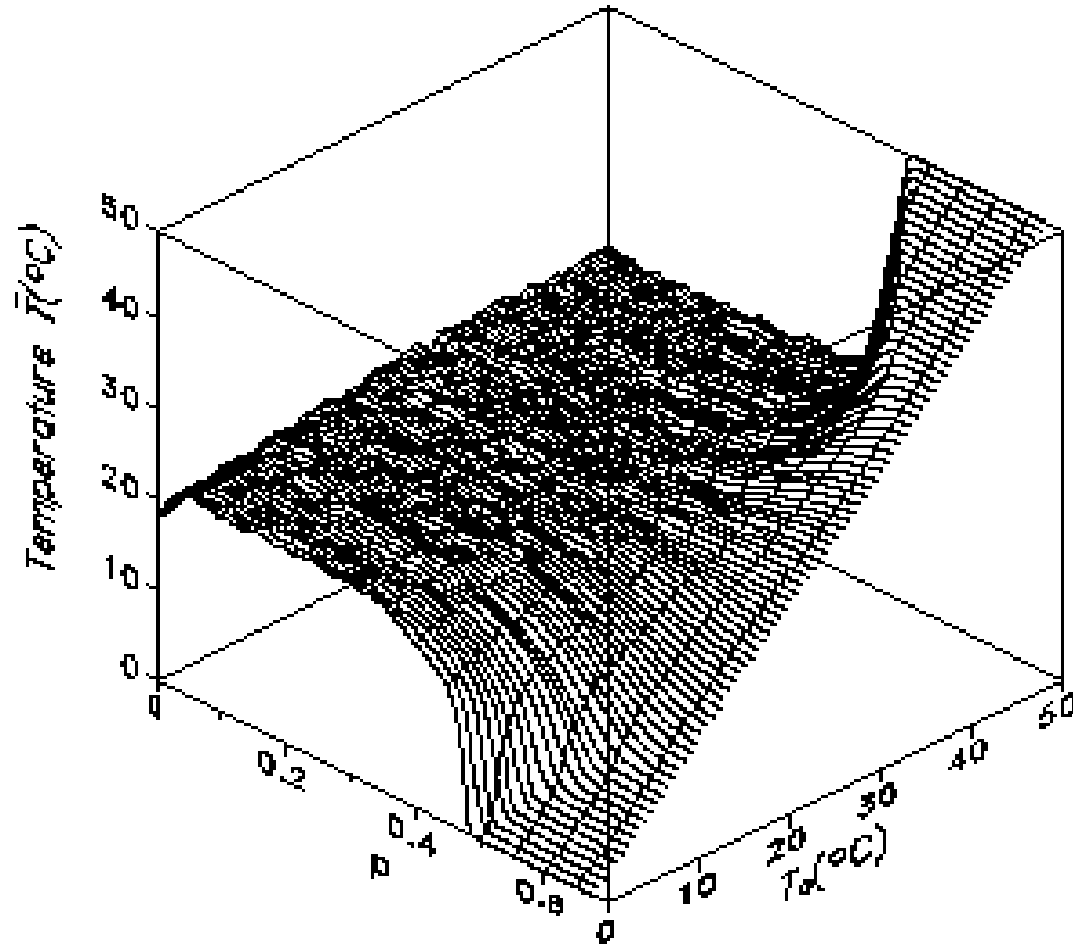

Global average temperature as a function of the fragmentation p and the temperature T_0 of the uncovered planet. (<http://www.pik-potsdam.de/~bloh/>)

Eisler's Thesis

	Old European Culture 7000 B.C.E. - 3500 B.C.E.	Kurgan Culture 4300 B.C.E. - 2800 B.C.E.
Economy	Agriculture (without the horse), sedentary	Pastoral (with the horse)
Habitat	Large aggregates villages and townships no hillforts	Small villages with semi-subterranean houses
Government	distributed, no hillforts	centralized, chieftains ruling from the hillfort
Social Structure	Egalitarian, matrilinear	Patriarchal, patrilocal
Ideology	Peaceful, art-loving, woman creatress	warlike, man creator

Noah's Flood

- During the Ice Age the Black Sea was an isolated freshwater lake surrounded by farmland.
- About 12,000 years ago, toward the end of the Ice Age, Earth began growing warmer. Vast sheets of ice that sprawled over the Northern Hemisphere began to melt. Oceans and seas grew deeper as a result.
- About 7,000 years ago the Mediterranean Sea swelled. Seawater pushed northward, slicing through what is now Turkey.
- Funneled through the narrow Bosphorus, the water hit the Black Sea with 200 times the force of Niagara Falls. Each day the Black Sea rose about six inches (15 centimeters), and coastal farms were flooded.
- Seared into the memories of terrified survivors, the tale of the flood was passed down through the generations and eventually became the Noah story.

Eisler's Thesis



Old Europe
ca. 7000B.C.E. - 3500 B.C.E.

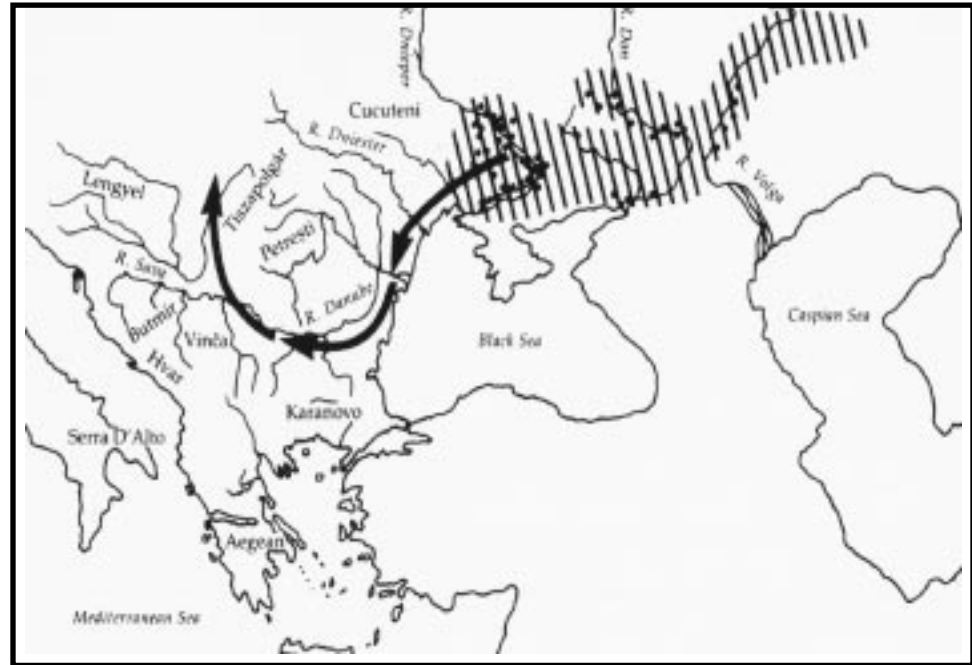

Kurgan Invasion Wave One
ca. 4300B.C.E. - 4200B.C.E.

The Prisoner's dilemma

	cooperate	defect
cooperate	10 10	12 5
defect	5 12	3 3

egoic

	cooperate	defect
cooperate	20	17
defect	17	6

ecologic

Iterated Prisoner's Dilemma on a Grid

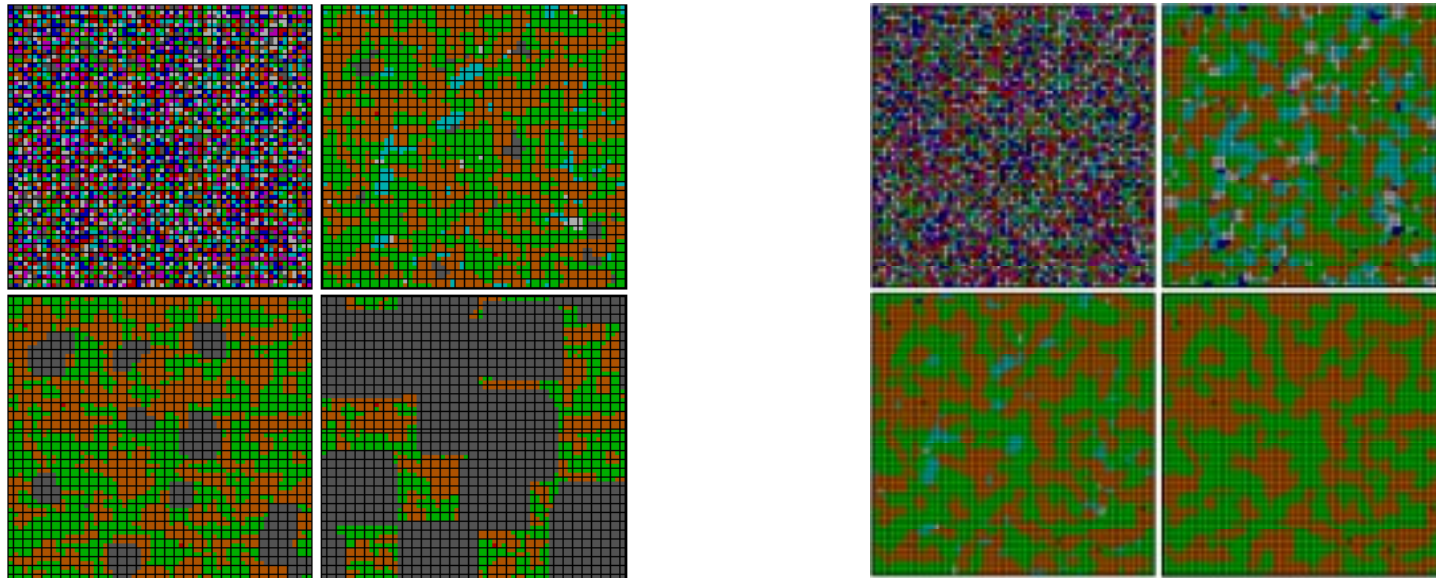

<http://www.sunysb.edu/philosophy/faculty/pgrim/SPATIALP.HTM>

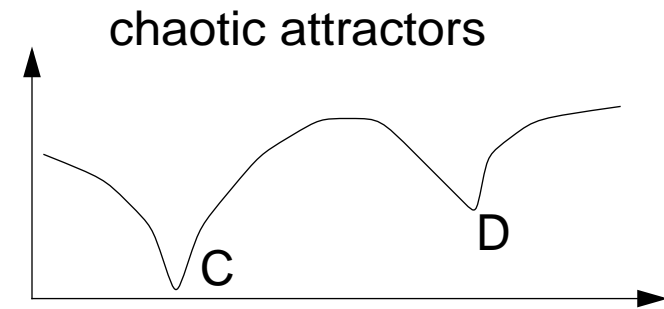
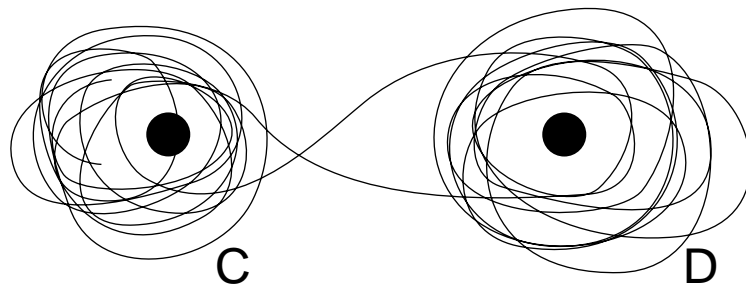

Real World Examples of “Intuitive Mode” Organizations

Meaning: non-hierarchical, shared information, distributed control, operating culture openly evolved by peer review, managed for the general good rather than to extract profit from proprietary structures...

- LINUX: In a two year period, the free software community produced an estimated 1 billion dollars of source code going from Linux RH6.2 to RH7.1
- The Internet: USENET, WWW
- The general progress of scientific understanding (non-ownership of fundamental laws, open publication, peer review, etc.)

"A human being is a part of the whole, called by us 'Universe,' a part limited in time and space. He experiences himself, his thoughts and feelings as something separated from the rest--a kind of optical delusion of his consciousness. This delusion is a kind of prison for us, restricting us to our personal desires and to affection for a few persons nearest to us. Our task must be to free ourselves from this prison by widening our circle of compassion to embrace all living creatures and the whole of nature in its beauty."

- Albert Einstein

Assorted References

Daisy World

Lovelock, James, *The Ages of Gaia: A Biography of our Living Earth*

W. von Bloh, “Daisyworld: a tutorial approach to geophysiological modelling” <http://www.pik-potsdam.de/~bloh/>

W. von Bloh, A. Block, and H.J. Schellnhuber, “Self-stabilization of the biosphere under global change: a tutorial geophysiological approach”, <http://www.pik-potsdam.de/~bloh/publications/vonbloh97/welcome.html>

Inman Harvey, “Daisyworld and Beyond, The Daisyworld Model” <http://www.cogs.susx.ac.uk/daisyworld/daisyworld.html> (good bibliography and links section)

Sigmoidal growth

Meyer, Jung, Ausubel, “A Primer on Logistic Growth and Substitution”, *Technological Forecasting & Social Change*, 1999, V61,3 p266, <http://phe.rockefeller.edu/LogletLab/logletlab.pdf>

Pop'n Growth in Limited Environments, *Fish & Wildlife Population Ecology*, Fall 1998 Course notes, University of Idaho, <http://www.its.uidaho.edu/wlf448/poplim1.htm>

Goedel's Theorem

Ernest Nagel and James R. Newman, “Goedel's proof”, New York University Press, 1958 - a sketch of the proof that formal logical methods are either incomplete or inconsistent. - implying that an intuitive, non-rational method must inform or extend logic to provide a fully working system for understanding the world.

Cooperative Social Structures

Riane Eisler, “The Chalice and the Blade”, Harper San Francisco, 1988. Archeological evidence for the existence of peaceful, cooperative social structures prior to the invention of war and agriculture.

Robert Axelrod, “The Evolution of Cooperation”, 1985 Basic Books. The thesis is that cooperation is the long-term winning evolutionary strategy.

Noah's flood

Walter Pitman, Anastasia Sotiropoulos, William B. F. Ryan, "Noah's Flood : The New Scientific Discoveries About the Event That Changed History", Touchstone books, 2000. (the most complete treatment of the research establishing the validity of the thesis)

<http://www.nationalgeographic.com/blacksea/ax/frame.html> (periodic updates on current underwater archeological studies in the Black Sea)

Ear Dancing

David T. Kemp, "New Discoveries about the Ear", Proceedings of the Royal Institution V59, 1987 pp. 185-213. - the ear is not a passive resonator - it "dances" with the sound. Training is required for deep musical hearing. A "ringing" ear actually emits sound! Making better sound reproduction systems is possibly wasted without spending equal effort to train the listener's ear.

Self-similarity, fractals, metaphor, and 1/f Noise

James Gleick, "Chaos : Making a New Science", 1998 Penguin. A good introduction to fractals, self-similarity, scaling of physical laws, and how chaos can be understood as orbits around chaotic attractors in n-dimensional space.

Marvin S. Keshner, "1/f Noise", Proceedings of the IEEE, V70 N3, March 1982.

William Stallings, "Viewpoint: Self-similarity upsets data traffic assumptions", IEEE Spectrum, January 1997, pp 28-29.

Quantum Computation and Classical Analogs of Quantum Computation

Ian Walsmsley, Results reported at the Lasers and Electro-Optics/Quantum Electrons and Laser Science Conference, week of May 12, 2001, Baltimore, MD. - shows that a computer based on classical optical interference provides quantum speedup in database access.

Peter Weiss, "Light shines in quantum-computing arena", Science News, Week of May 19, 2001, V159, N2.

Nielsen and Chuan, "Quantum Computation and Quantum Information", 2000 Cambridge University Press - an excellent tutorial covering the field of Quantum computation.

Egoic consciousness and Body-mind in Martial Arts

Shi Ming and Sia Weijia, in translation by Thomas Clearly, "Mind over matter - higher martial arts", 1994, Frog Books Ltd, North Atlantic Books.

A current view of Neuroscience

Susan Greenfield, "The private life of the brain", John Wiley and Sons 2000.

Tim Beardsley, "Debunking the digital brain", Scientific American <http://www.sciam.com/explorations/020397brain/020397explorations.html>

Gabriel Kreiman, Christof Koch and Itzhak Fried. Imagery neurons in the human brain Nature (2000) 408, 357-361

Comparison of East/West models of consciousness

Alan Watts, "Psychotherapy East and West", 1961, Ballantine Books. Freudian and Jungian Psychology compared with Buddhism, Vedanta, Yoga, and Taoism.

Betty Edwards, "Drawing on the Right Side of the Brain", 1989 Tarcher Putnam - demonstrate how verbal thought interferes with vision and drawing, with exercises to develop an artistic eye.

Ken Wilber, Jack Engler and Daniel P. Brown, "Transformations of Consciousness", 1986 Shambala - presents a model synthesizing modern psychology, psychiatry as well as the world's meditative traditions to describe the full spectrum of human psychological and mental potential.

Overview of Meditation Techniques and Theory

David Fontana, "The Meditator's Handbook - A comprehensive guide to Eastern and Western Meditation Techniques", 1992 Element.

The case for consciousness being a Turing emulator of reality

David Deutsch, "The Fabric of Reality", 1997 Allen Lane. - makes a case for Quantum physics, evolution, computation theory and epistemology as jointly providing the basis for a "Theory of Everything".

Libet's experiment showing 500ms delay in egoic consciousness

Roger Penrose, "The large, the small and the human mind", 1997 Cambridge Press. - a popular presentation of the experiment.

Finite and Infinite Games

James P. Carse, "Finite and Infinite Games - a vision of life as play and possibility", 1986 Ballantine. Brilliant.

The Prisoner's Dilemma

William Poundstone, "Prisoner's Dilemma/John Von Neumann, Game Theory and the Puzzle of the Bomb", 1993 Anchor. Excellent introduction to the prisoner's dilemma, game theory and the double bind of the cold war.

<http://www.sunysb.edu/philosophy/faculty/pgrim/SPATIALP.HTM> Iterated Prisoner's dilemma on a grid.

Holographic Storage

<http://www.almaden.ibm.com/st/projects/holography>

www.nottingham.ac.uk/~ppyr/tcc/Applications.htm#holography/